

**CLARK COUNTY
DEPARTMENT OF AVIATION
LEASE AGREEMENT
MCCARRAN INTERNATIONAL AIRPORT**

THIS LEASE AGREEMENT, hereinafter referred to as "Agreement," is entered into this _____ day of _____, 2021, by and between COUNTY OF CLARK, a political subdivision of the State of Nevada, through its Department of Aviation, hereinafter referred to as "Aviation," and **UNIVERSITY MEDICAL CENTER OF SOUTHERN NEVADA**, a publicly owned and operated County hospital created pursuant to NRS Chapter 450, authorized to do business in the State of Nevada, hereinafter referred to as "Company": Aviation and Company are referred to herein individually as a "Party" and collectively as the "Parties."

W I T N E S S E T H

WHEREAS, Aviation is responsible for the management and control of the Clark County Airport System, as defined under Clark County Code, Title 20, which includes McCarran International Airport, hereinafter "Airport," and has the right to lease portions of the Airport and to grant operating privileges thereon subject to the terms and conditions hereinafter set forth; and

WHEREAS, Company desires to operate a medical clinic; and

WHEREAS, it is the desire of Aviation and Company that this Agreement be entered into pursuant to Nevada Revised Statute 496.090;

NOW, THEREFORE, for and in consideration of the agreements, covenants and conditions herein, Aviation and Company agree as follows:

ARTICLE I

1.1 DEFINITIONS

- 1.1.1 The term “Airport” shall mean McCarran International Airport and all property and Improvements contained within its general environs at the Effective Date of this Agreement.
- 1.1.2 The term “Assigned Areas”, whenever used herein, means the area defined as Exhibit “A” attached hereto. The Assigned Areas may be modified by Aviation as provided in Section 1.3.2 of this Agreement. Any modifications to Exhibit “A” will be completed by Aviation and attached as part hereof by an exchange of correspondence between parties.
- 1.1.3 The term “Aviation” or “Department of Aviation” or “DOA” shall mean the Department of Clark County responsible for the management and oversight of the County’s Airport System, as defined in Clark County Code, Title 20 Ordinance. The use of the term Aviation or County shall be interchangeable within this Agreement.
- 1.1.4 The term “Beneficial Occupancy Date” or “BOD” shall mean the date that Company commences, or is obligated to commence, business operations from any Assigned Areas. The Beneficial Occupancy Date will be established by Aviation through written correspondence to Company.
- 1.1.5 The term “Commence Construction” shall mean beginning construction of Improvements to the Assigned Areas by Company causing its construction contractor to have access to the area and begin actual site development thereon.
- 1.1.6 The term “Company” shall mean **UNIVERSITY MEDICAL CENTER OF SOUTHERN NEVADA**, a publicly owned and operated County hospital created pursuant to NRS Chapter 450, as the operator of a medical clinic at the Assigned Area(s), under this Agreement.
- 1.1.7 The term “Company’s Agents” shall mean Company’s authorized representatives, including, but limited to, employees, invitees, officers, agents, representatives, contractors, subcontractors, suppliers, independent contractors, and/or sublessees acting for, on behalf of, or with Company’s authorization.
- 1.1.8 The term “Construction Completion Date” shall mean the date construction has been completed as evidenced by a valid Certificate of Occupancy or Temporary Certificate of Occupancy, **whichever occurs first**. Company shall notify Aviation in writing of its receipt of such permanent or Temporary Certificate of Occupancy and provide a copy to Aviation within thirty (30) days of its issuance.
- 1.1.9 The term “County” shall mean County of Clark, a political subdivision of the State of

Nevada, as represented by the Clark County Board of Commissioners. All references to the County in this Agreement shall include its Department of Aviation.

- 1.1.10 The term “Director” shall mean the Clark County Director of Aviation or his/her designee.
- 1.1.11 The term “Effective Date” shall mean the date the Agreement is approved by official action of the Board of County Commissioners.
- 1.1.12 The term “Emergency” shall mean any situation, health or safety concern, incident, or action that is determined, at Director’s sole discretion, may cause or has caused structural hazardous or other similar catastrophic damage to the Assigned Areas or surrounding areas.
- 1.1.13 The term “Environmental Laws” shall mean any one or all of the laws and/or regulations of the Environmental Protection Agency or any other federal, state, or local agencies, including, but not limited to, the regulations listed below, as may be amended from time to time.
 - A. COMPREHENSIVE ENVIRONMENTAL RESPONSE, COMPENSATION AND LIABILITY ACT (42 U.S.C. Section 9601 et seq.)
 - B. RESOURCE CONSERVATION AND RECOVERY ACT (42 U.S.C. Section 6941 et seq.)
 - C. TOXIC SUBSTANCES CONTROL ACT (15 U.S.C. Section 2601 et seq.)
 - D. SAFE DRINKING WATER ACT (42 U.S.C. Section 300h et seq.)
 - E. CLEAN WATER ACT (33 U.S.C. Section 1251 et seq.)
 - F. CLEAN AIR ACT (42 U.S.C. Section 7401 et seq.)
 - G. SANITATION (Nevada Revised Statutes, Chapter 444)
 - H. NEVADA WATER POLLUTION CONTROL LAW (Nevada Revised Statutes 445.131 through 445.399)
 - I. HAZARDOUS MATERIALS, INCLUDING UNDERGROUND STORAGE TANK REGULATIONS (Nevada Revised Statutes, Chapter 459)
 - J. OCCUPATIONAL SAFETY AND HEALTH ADMINISTRATION (OSHA) (29 CFR, Sections 1910 and 1926)

and regulations promulgated thereunder and any other laws, regulations and

ordinances (whether enacted by the federal, state or local government) now in effect or hereafter enacted that deal with the regulation or protection of the environment, including, but not limited to, ambient air procedures and records detailing chlorofluorocarbons (CFC), ambient air, ground water, surface water and land use, including sub-strata land.

1.1.14 The term “Hazardous Material” shall mean the definitions of hazardous substance, hazardous material, toxic substance, regulated substance or solid waste as defined in the applicable regulations, including, but not limited to, the regulations listed below, as may be amended from time to time:

- A. COMPREHENSIVE ENVIRONMENTAL RESPONSE, COMPENSATION AND LIABILITY ACT (42 U.S.C. Section 9601 et seq.)
- B. RESOURCE CONSERVATION AND RECOVERY ACT (42 U.S.C. Section 6941 et seq.)
- C. HAZARDOUS MATERIALS TRANSPORTATION ACT (49 U.S.C. Section 1801 et seq.)
- D. DEPARTMENT OF TRANSPORTATION TABLE (49 C.F.R. Section 172.101) and amendments thereto.
- E. ENVIRONMENTAL PROTECTION AGENCY (40 C.F.R. Part 302 and amendments thereto)
- F. TRANSPORTATION OF HAZARDOUS MATERIALS BY MOTOR VEHICLE (Nevada Revised Statutes 459.700 through 459.780)

and, all present or future regulations promulgated thereto; and all substances, materials and wastes that are, or that become, regulated under, or that are, or that become classified as hazardous or toxic under any environmental law, whether such laws are federal, state or local.

1.1.15 The term “Improvements” shall mean the construction or installation of all real property and personal property improvements commonly considered to be Improvements, including, but not limited to, (interior, decorative, utilities (up to and within the Assigned Areas), necessary finishes, electrical, telephone, communication conduit and cabling, accessories, piping, ductwork, equipment, and fixtures to complete the appearance and operating characteristics of the specialty retail concession facility(ies), as well as all applicable permits, zoning requirements, as required by Company for the operation of its business under this Agreement. Notwithstanding the assumption of any of these responsibilities by a sublessee, Company shall remain responsible to ensure all Improvements are completed in accordance with the terms of this Agreement and the McCarran International Airport

Tenant Improvement Manual.

- 1.1.16 The term “Release” shall mean any releasing, spilling, leaking, pumping, pouring, emitting, emptying, discharging, injecting, escaping, leaching, disposing or dumping of any Hazardous Material as defined hereinabove, in violation of the Environmental Laws.

1.2 TERM

- 1.2.1 The Term of this Agreement will commence on the Effective Date and will continue for a period of five (5) years (“Term”) from the BOD, unless otherwise terminated as provided in Sections 2.15 and 2.16 of this Agreement. Upon the Effective Date, this Agreement shall supersede and terminate any and all prior agreements between the Company and Aviation.

By mutual consent, Aviation and Company shall have the option to extend this Agreement for one (1) additional five (5) year period. If, without objection by Aviation, Company maintains possession of the Assigned Areas after the expiration of the Term this Agreement, including any extensions, Company shall become a tenant from month-to-month upon the terms of this Agreement. However, no such month-to-month tenancy shall be deemed to operate as a renewal or extension of the Term. Such month-to-month tenancy may be terminated by Aviation or Company by giving thirty (30) days written notice of termination to the other party at any time during the month-to-month tenancy period.

1.3 ASSIGNED AREAS

- 1.3.1 Aviation acknowledges that this Agreement may pertain to certain areas which are already constructed and operating for business as well as locations for which improvements remain to be completed, all of which are identified on Exhibit “A” and together constitute the “Assigned Areas” as that term is used in this Agreement.
- 1.3.2 **Additions or Modifications to Assigned Areas:** Any further modification to the Assigned Areas for areas leased to Company shall be accomplished through the issuance of a Space Use Letter, executed by the Director, detailing the specific terms and conditions of any such modification. It is hereby understood and agreed that any new space assignment that may be needed to meet the operational needs of the Airport will be construed under the general terms and conditions of this Agreement. Company’s continued occupation or use of any portion of the Assigned Areas shall be deemed as Company’s consent to all terms and conditions of the Space Use Letter. If the Company has any objections, the Company must immediately notify Aviation by no later than five (5) business days upon receipt of the Space Use Letter.
- 1.3.3 Company acknowledges that the Director will assign the use of any Assigned Areas, ramp areas, or other designated areas of the Airport for use by Company, in a manner

to ensure the best utilization of the Airport to meet the operational needs of the Airport and available facilities. Company acknowledges that such assignments will be determined at the sole discretion of the Director. Company hereby acknowledges that Aviation may relocate airline(s) from time to time to meet the operational needs of the Airport, as determined solely by Aviation, and that said relocation of airline(s) may reduce the traffic in the Assigned Areas and surrounding areas. Aviation will not be held responsible or be otherwise liable for any loss of business under this or similar circumstances as described herein.

- 1.3.4 The Assigned Areas may be re-assigned or otherwise modified from time to time. Company shall request prior written approval from Director for use of any designated areas outside of its Assigned Areas prior to the commencement of any activity. Failure to comply with this requirement may result in the termination of this Agreement by the Director.
- 1.3.5 Upon reassignment of Assigned Areas or termination of this Agreement, howsoever caused, Company will vacate any area(s) or Assigned Areas, as applicable, and return the area to its original condition, normal wear and tear excepted, or as otherwise directed in writing by Aviation, within the time frame identified by Aviation. Aviation shall not bear any costs for such relocation or reassignment except as otherwise set forth in this Agreement.
- 1.3.6 **Inspection of Assigned Areas:** Company acknowledges that it has inspected the Assigned Areas and is fully cognizant of the present conditions, including but not limited to utilities. Company also acknowledges and accepts the Assigned Areas in “AS IS,” “WHERE IS,” and in “WITH ALL FAULTS” condition, including, but not limited to, grades, building, and drainage with no further responsibility to Company by Aviation for any present or further Improvements or other maintenance.
- 1.3.7 Company agrees to maintain the Assigned Areas and any improvements placed thereon by Company to such a standard of appearance as is suitable to Aviation in order that said Assigned Areas will not diminish or in any manner detract from the appearance of the Airport’s interiors. Company shall be solely responsible for all costs and fees required to maintain the Assigned Areas and improvements in the manner described above.
- 1.3.8 Company agrees to maintain the Assigned Areas and any improvements placed thereon by Company to such a standard of appearance as is suitable to County in order that said Assigned Areas will not diminish or in any manner detract from the appearance of the Airport’s interiors. Should Company fail to maintain the Assigned Areas and improvements in the manner described above, County may, but is not obligated to, effect such maintenance or make repairs thereon and thereto which it feels are necessary, and charge the same at the sole expense of Company, plus a fifteen percent (15%) administrative fee.

1.3.8.1 Capital investment in the subject Assigned Areas shall be undertaken in such amounts and at such times, as necessary in order to prevent Assigned Areas from appearing worn or shabby to its patrons. The determination as to whether Assigned Areas appear worn or shabby shall be made by CDR, in its sole and absolute discretion, and such determination shall be final and binding upon Company.

1.3.9 Additionally, Company agrees to maintain hand sanitizer units throughout the terminal buildings and the McCarran Rent-A-Car Center (Exhibit A). Company will be permitted to brand these units with the UMC brand. Company will not place branding and advertising for any third party without prior written consent from Aviation. Such third party advertising will be subject to the standard Airport indoor advertising fee. Company will maintain the hand sanitizer units to the same standards of appearance as the clinic itself.

1.3.9.1 Company may request to relocate the hand sanitizer units from time to time, in writing to Aviation. Aviation will respond to Company's request within 10 business days. Company agrees that any relocations of the hand sanitizer units will not conflict with Contracted Advertising at the Airport.

1.4 USE OF ASSIGNED AREAS

1.4.1 **Authorized Uses:** Upon the performance of the agreements, provisions and conditions contained in this Agreement, Company will have the use of the Assigned Areas or designated areas of the Airport, as assigned by the Director, for the purposes necessary and incidental to operating, as outlined below and for no other purposes except as may be approved in advance and in writing by the Director. Aviation retains the sole right to determine if a use is compatible with Airport operations.

1.4.2 Company, or Company's Agents, will not transact or otherwise engage in any other activities, business, and/or services, except as described in this Section 1.4 of this Agreement, at or on the Airport, unless such is provided for by a separate written agreement or amendment to this Agreement with Aviation.

1.4.3 Company, on an exclusive basis, will operate a medical clinic and related Services, including, but not limited to, the following:

"SERVICES" (such term including medically prescribed or provided products):
Primary urgent care, medical screening exams, employment and other physicals, Rapid/PCR Covid-19 Testing, rehabilitation services, vaccines, immunizations, treatment for non-critical and emergency medical conditions, flu, colds, respiratory infections, sinus & allergies, dehydration/IV fluids, sprains, strains, lacerations, bronchitis, sore throat, asthma, UTI, headaches, backaches, medical lab testing, routine medical care, and medically prescribed for the care or treatment of patients..

Company shall coordinate with the Clark County Fire Department (onsite) and the Southern Nevada Health District regarding protocols and procedures related to outbreak, quarantine and other special needs emergency situations in both pre-planning and response capacities.

The Assigned Areas shall not be used to house or provide for extended care patients.

- 1.4.4 **Exclusive Use & Healthcare Services:** Subject to 2.23, Aviation represents, warrants, and covenants that from and after the Effective Date through the termination of this Agreement, neither Aviation nor any Aviation Affiliate, successor or assigns, will lease any space in the Airport Center (except the Assigned Areas hereby demised) as the same may now exist or as now being reconstructed or as enlarged or altered at any time in the future, or permit the use or occupancy of any such space, whether at wholesale or at retail, to any tenant or other occupant which would violate Company's exclusive use under Section 1.4.3.

Company shall have the exclusive right to display UMC logo on all hand sanitizers throughout the Airport and UMC signage will be placed in designated areas of the airport.

- 1.4.5 It is understood and agreed by the parties that the privilege to operate a medical clinic and provide related services within the Assigned Areas is limited by the terms and conditions of this Agreement. If, in the sole judgment of Aviation, Company is promoting or offering services and/or additional items for sale not included within the scope of this Agreement, Aviation shall give Company written notice of such violation. Company will have twenty-four (24) hours to remedy the violation cited in the written notice. If Company fails to remedy the violation, or if the violation habitually recurs, as determined solely by Aviation, it shall be considered a material breach of this Agreement, and Aviation will have the right to terminate this Agreement under the terms of Section 2.15.
- 1.4.6 The standards of operation, as pertaining to the quality of service from the Assigned Areas afforded to the general public, will be at least equal to the quality of service provided at similar operations. At all times, the general public will be given the highest consideration in matters effecting the operation and use of the Assigned Areas. If, at Director's sole discretion, Company is offering services and/or items for sale of a quality less than considered top quality in such services and/or the line of merchandise sold, written notice will be given to Company by Aviation of such violation, and Company will be required to remove and/or replace substandard services and/or merchandise within a specified time frame. Failure of Company to remove or replace specified services within the time specified by Aviation shall be considered a material breach of this Agreement, and will be subject to termination as provided for in Section 2.15 of this Agreement.

1.4.7 **Pricing Policy:** Company acknowledges and agrees that the prices charged for the authorized goods and services provided by Company within the Assigned Areas must be reasonable, as compared to other Company locations offering comparable concept items and/or services.

1.4.8 **Performance Standards:** Company agrees to comply with the performance standards, as further outlined in Exhibit "B," attached hereto and by reference made a part hereof, and as may be further identified by Director and mutually agreed to by both parties. Company agrees to track its performance and make such reports as Director may request from time to time.

Company recognizes the importance of customer service in the Las Vegas Community and the traveling public. As such, Company will have sufficient personnel available to meet the needs of its customers and provide a high level of customer service in all areas of Company's operations, including, but not limited to, peak operating hours.

1.4.9 **Hours of Operations:** Company must submit hours of operation to the Director prior to the BOD. These hours of operation may be increased at any time by Company, but may only be decreased with prior written approval from the Director.

1.4.10 **Ingress and Egress:** Company has the nonexclusive right of reasonable ingress to and egress from its Assigned Areas over Airport System roadways, including common-use roadways, subject to any rules or security regulations which may have been established or shall be established in the future by the Director, County, the Federal Aviation Administration (FAA), Transportation Security Administration (TSA), and/or the State of Nevada. Such right of reasonable ingress and egress shall apply to Company's Agents. The right of ingress and egress likewise applies to the transport of equipment, material, machinery and other property related to Company's authorized business under this Agreement. Company will have the nonexclusive right, in common with other Airport tenants and the general public, for ingress and egress to the Airport. Company or Company's Agents will not have the right of free vehicle parking in the Airport's public parking lots.

1.4.11 Should a conflict ever arise between Company and other operators at the Airport regarding use of the Assigned Areas, the Director shall resolve the conflict and Company agrees to abide by the Director's decision. Notwithstanding the preceding, Company may, as appropriate, appeal such decision.

1.5 RENTALS, FEES, AND CHARGES

1.5.1 Commencing upon the Beneficial Occupancy Date of this Agreement, Company will pay a monthly rent to Aviation for the Assigned Area as follows:

The Assigned Area consists of approximately one thousand four hundred forty and

20/100 (1,440.20) square feet of space and Company shall pay rental at the rate of twenty-five and 90/100 dollars (\$25.90) per square foot per annum payable monthly, in advance payments of three thousand one hundred eight and 43/100 dollars (\$3,108.43).

- 1.5.2 **Badging and Fingerprinting Fees:** In accordance with Section 2.9 and the Airport Security Program, Company must obtain Airport security badging and fingerprinting for its eligible Company Agents and pay the related costs associated with this privilege. Company shall pay to Aviation those rates and fees in effect at the time of issuance. Company shall contact the Airport Badging Office (702) 261-5652, regarding the requirements of this Section 1.5.2.
- 1.5.3 **Employee Parking Fees:** Parking for Company's Agents working at the Airport may be available in a parking area as determined by the Director at rates as established in Clark County Code, Title 20. Company must provide Aviation with the names of eligible employees and make arrangements for monthly invoicing for the charges. Company shall contact the Airport Parking Office (702) 261-5186, regarding the requirements of this Section 1.5.3.
- 1.5.4 **Redetermination of Rents, Fees, and Charges:** Aviation reserves the right to redetermine all rentals, fees, and charges at least every three (3) years from the BOD of this Agreement, unless otherwise modified by Clark County Code, Title 20. Further, Aviation reserves the right to redetermine all rentals, fees, and charges contained herein at any time after three (3) years have passed since the most recent adjustment. All such adjustments shall be subject to ninety (90) days prior written notice to Company from the Director. Due to the fact that similarly situated tenants have different anniversary or other rental adjustment dates, Aviation does not warrant that the rents and fees will be exactly the same at all times for all similarly situated tenants. If Company does not agree with such redetermined rents and fees, it has the right to cancel this Agreement as provided for in Section 2.17, of this Agreement, with ninety (90) days written notice as provided in Section 2.17 of this Agreement, it being understood that Company will not be subject to the redetermined rents and fees during such ninety (90) day period.
- 1.5.5 **Proration of Rentals:** In the event such possession, use, and occupancy of the Assigned Areas or any portion thereof should commence or terminate on a date other than the first day of a calendar month, then the rental for the Assigned Areas will be prorated to reflect the actual number of days during which the Company will have enjoyed the possession, use and occupancy of said Assigned Areas.
- 1.5.6 **Other Payments:** Company agrees to pay Aviation within thirty (30) days of receipt of invoice for charges that become due to Aviation under this Agreement, or as outlined in Clark County Code, Title 20.
- 1.5.7 **Late Fees:** Aviation will not be prevented from terminating this Agreement pursuant

to the provisions for default of payments of rentals and fees or charges or from enforcing any other provisions contained herein or implied by law.

1.6 METHOD OF PAYMENT AND REPORTS

- 1.6.1 Company will make all payments by check made payable to the Clark County Department of Aviation, or other form of payment acceptable to Aviation, and deliver or mail said payments to the Clark County Department of Aviation, Finance Division, P.O. Box 11005, Las Vegas, NV 89111-1005, or to such other place as Aviation may direct Company in writing on or before the due dates as outlined in Section 1.5 of this Agreement.
- 1.6.2 All other amounts due to Aviation from Company, whether for utility or maintenance or other charges as provided herein, will be paid by Company within fifteen (15) days of the date of the invoice.
- 1.6.3 Company will be required to submit monthly usage reports.
- 1.6.4 Company will submit any other information reasonably requested by Aviation through its Director pertaining to Company's operations permitted hereunder.

1.7 *Intentionally deleted. RECORDS AND AUDIT*

1.8 UTILITIES

- 1.8.1 Company shall be responsible for and agrees to pay all recurring and nonrecurring costs for utilities (whether for installation, service, connections or maintenance thereof) used by Company at or upon the Assigned Areas with no responsibility or expense incurred by Aviation, as required by Aviation. Such payment, by Company, will be made directly to the utility supplier, except that if any such utilities should be supplied by Aviation, then in this event, Company shall pay those costs to Aviation within fifteen (15) days of receipt of invoices. Aviation agrees that any such costs invoiced to Company will be at the rates charged to Aviation by the utility supplier.
- 1.8.2 Company shall contract with its telecommunications provider for any telephone systems. Company shall coordinate all telecommunications with Aviation prior to installation and Company shall be responsible for all connection fees and any recurring periodic charges. Company shall also be responsible for all computer and/or communications systems, which must be approved by the Director, including the payments of installation, maintenance, and/or recurring periodic charges.
- 1.8.3 Company shall be responsible for, at its sole cost, installation, connection, and payment of all utilities, including, but not limited to underground utility lines and connections from the nearest location (approved by the Director) to the improvements as desired within the leased Assigned Areas. Company's expense will

include connection fees, metering fee, maintenance and repair costs for such underground utility lines, and all recurring periodic utility services charges required to operate the Assigned Areas throughout the Term of this Agreement.

- 1.8.4 Company shall be responsible for installation, connection, and payment of meters and/or sub-meters (as may be applicable) for all utilities, including, but not limited to, electric, gas, sewer, hot water and chilled water at Assigned Areas as required by Aviation.
- 1.8.5 With sixty (60) day prior written notice from Aviation, Company will be responsible for the payment to Aviation for electrical consumption. In accordance with NV Energy's Rule 18 and the Regulations of the Public Utility Commission of Nevada (Nevada Administrative Code 704.8805 through 704.8807) electric consumption will be sub-metered by Aviation. The monthly charge shall not exceed the total amount Company would have been charged had it been billed directly by NV Energy.
- 1.8.6 With sixty (60) day prior written notice from Aviation, Company will be responsible for the payment to Aviation for chilled water consumption. Chilled water consumption will be sub-metered by Aviation. The monthly charge will be based on Company's pro-rata share of the amount billed to Aviation by NV Energy.
- 1.8.7 With sixty (60) day prior written notice from Aviation, Company will be responsible for the payment to Aviation for hot water consumption. Hot water consumption will be sub-metered by Aviation. The monthly charge will be based on the pro-rata share of the amount billed to Aviation by NV Energy and/or Southwest Gas.
- 1.8.8 Company shall be responsible for the connection of additional utilities and recurring periodical charges to operate the Assigned Areas which are over and above the basic utilities provided by Aviation.

1.9 FACILITIES, MAINTENANCE, AND REPAIR – AVIATION

In the operation of Company's activities within the Assigned Areas, Aviation will provide and maintain the following:

- 1.9.1 Access to electricity, telephone and other electrical-based utilities will be available in a panel identified by Aviation.
- 1.9.2 Access to facilities to install sub-meters for electric, hot water and chilled water.
- 1.9.3 Chilled and hot hydronic water supply at and up to source connection point as designated by owner, feeding tenant-owned and maintained branch hydronic lines, isolation valves and air conditioning units (as applicable) serving the Assigned Areas.
- 1.9.4 Domestic cold water.

- 1.9.5 Systems repair to basic utilities at the Assigned Areas.
- 1.9.6 All building exterior and structural repairs to the Airport's Terminal Building, except those made necessary by negligence or willful misconduct on the part of Company or its clients, employees, agents, contractors, or subcontractors.
- 1.9.7 Maintenance and repair of the common use areas of the building including, but not limited to, common use access doors, hallways and common use restrooms. In the event that any repair is required by reason of the negligence or abuse of Company or Company's Agents, or any other person using the Assigned Areas with Company's consent, express or implied, Aviation may make such repair and bill Company at cost and add fifteen percent (15%) for administration of the repairs.

1.10 FACILITIES, MAINTENANCE, AND REPAIR - COMPANY

It is understood that Company will provide and maintain, at Company's sole expense, the following:

- 1.10.1 Preventive maintenance, repair, and replacements of all Improvements, as defined in Section 1.1 of this Agreement, to the Assigned Areas in a manner and within timeframes approved by Aviation. All Improvements will include, but not be limited to, the necessary finishes, electrical, telephone, communication conduit, accessories, piping, ductwork, equipment, fixtures, decorations, and any other furnishings necessary for Company's operation, appearance and operating characteristics of the retail facility.
- 1.10.2 Company will perform, ordinary preventive maintenance, ordinary upkeep, and repair of all facilities, personal property, and equipment, including, but not limited to, fixtures, doors and windows, floor coverings, all electrical work, plumbing, appliances, and fixtures, within its Assigned Areas and other facilities that may be used or occupied by Company from time to time, excepting repairs or damage arising from ordinary wear and tear. Company shall also be responsible for the following, as applicable:
 - A. Heating and air conditioning within the Assigned Areas that are over and above Airport wide system repair.
 - B. Building structural repairs and maintenance as a result of any negligent or willful actions or non-actions of Company, or Company's Agents.
 - C. All Assigned Areas interior maintenance and repair, including, but not limited to, the replacement of light bulbs, tubes, doors, gates, and fixtures, including additional or decorative lighting.

- D. Company will design, develop, construct, manage, and repair all leasehold Improvements, including, but not limited to grading, fencing, paving, lighting, roadways, parking lots, drainage, all applicable permits, zoning requirements as required by Company for the operation of the Assigned Areas in accordance with the terms and conditions of this Agreement. Notwithstanding the assumption of any of these responsibilities by a sublessee, Company shall remain responsible to ensure all leasehold Improvements are completed in accordance with this Agreement. The provisions of this Section shall control in the event of any conflict with a sublease.
 - E. Repair and maintenance of the Assigned Areas shall be completed on or before a date required by Aviation through written correspondence to Company.
 - F. Installation of sub-meters for electric, hot water and chilled water at Assigned Areas as required by Aviation.
 - G. Connection of additional utilities and recurring periodical charges to operate the Assigned Areas which are over and above the basic utilities provided by Aviation.
- 1.10.3 Any modifications or connections to existing interior walls, heating, air conditioning, plumbing, communication/data, and electrical systems as required by Aviation, including the payment of connection fees and any recurring periodic charges. All installations or alterations which have been approved by the Director will be in accordance with the Airport Tenant Improvement Manual, applicable code, Airport Rules and Regulations and Operating Directives, and all other applicable governmental rules and regulations and building codes.
- 1.10.4 Company shall develop, maintain, and keep its Assigned Areas in a safe, clean and orderly condition at all times. Company is responsible for all repair, maintenance and janitorial service and requirements, including, but not limited to, daily routine clean-up, storefront and/or window wall cleaning, and garbage disposal within the Assigned Areas and to keep the Assigned Areas in good and tenantable condition throughout the Term of this Agreement. Company will provide and use suitable, covered, sturdily-constructed receptacles which are screened from public view for all garbage, trash, and other refuse created on or arising in connection with the activities conducted in the Assigned Areas. Company will be responsible for the proper removal and disposal of all garbage, debris, contaminants, and any other waste material (whether solid or liquid) from the Assigned Areas or out of its operation at other locations of the Airport. Such removal will conform to all governmental requirements and regulations. Such removal and disposal of garbage, debris, contaminants, or other waste material is understood to include routine daily clean-up of the surrounding areas.

- 1.10.5 Company will properly store all items within the Assigned Areas in a manner that keeps such areas free from litter, debris, foreign object debris (FOD), refuse, petroleum products, or grease that may result from activities of Company or Company's Agents in accordance with the Airport Rules and Regulations and Operating Directives.
- 1.10.6 In the operation of Company's activities within the Assigned Areas, Company agrees to routinely inspect its Assigned Areas as well as any and all operating areas, whether owned, operated, maintained, or otherwise under the control of Company, that is used by Company in the conduct of its business at the Airport, for any damage that may exist and/or repairs that may be required. Company shall report any such findings to Aviation, through the Airport Control Center, within two (2) hours of its inspection, unless otherwise deemed to require an immediate response or an emergency. Upon Company's inspection and subsequent notification to Aviation, Company will not utilize such facilities and Company will also block off the area with safety cones or other similar safety devices to keep the public from entering the area that requires attention, maintenance, or repair. Company shall accept full liability for its use of the area.
- 1.10.7 Company shall immediately repair any damage to Assigned Areas or any other space at the Airport caused by the fault or negligence of Company or Company's Agents, and not covered by insurance carried by Company. Aviation, at its option, may make such repairs and Company agrees to reimburse Aviation for its costs for labor and materials plus a twenty percent (20%) administrative fee.
- 1.10.8 Company will provide and maintain a local twenty-four (24) hour monitored telephone for emergency service requests that may be required. Any such calls and/or requests for service shall be responded to within a fifteen (15) minute period maximum and a qualified individual shall be on site as required within a thirty (30) minute period, maximum, unless otherwise advised.
- 1.10.9 Should Company fail to perform any of its maintenance and repair responsibilities, Aviation may, but is not obligated to, provide maintenance and make repairs thereon and thereto which it determines to be necessary, charging the same to the expense of the Company upon thirty (30) days prior written notice of its intent to do so; except in the case of emergency for which no notice is necessary, plus twenty percent (20%) administrative fee.
- 1.10.10 Company will conduct business activities at the Airport that are in compliance with all applicable provisions of the Americans with Disabilities Act of 1990, as amended from time to time, including the adoption of updated ADA Standards for Accessible Design (2010 Standards).

1.11 USE OF EQUIPMENT

- 1.11.1 It is acknowledged by Aviation that Company may use certain vehicles and equipment in the operation of its business pursuant to this Agreement. The use and movement of these vehicles and equipment in, on, and about the Assigned Areas, ramp areas, and any other areas of the Airport are covered by the terms of this Agreement. When not in use, the vehicles and other equipment will be parked within the Assigned Areas or other area as specifically instructed by the Director. Company will provide the Director with a current list of its owned or leased automotive equipment to be utilized under this Agreement.
- 1.11.2 Company agrees that it will provide sufficient equipment to meet the needs of its customers during all operational hours, including, but not limited to, peak hours and/or special events. When not in use, the vehicles and other equipment will be parked within the Assigned Areas or other areas as specifically instructed by Aviation.
- 1.11.3 All equipment will be operated by Company and Company's Agents in a safe and orderly manner at all times and in accordance with the responsible safety and traffic practices, with any Rules and Regulations, Operating Directives, and/or procedures established by Aviation or any other governmental agency.
- 1.11.4 All equipment to be used in the operation of Company's business at the Airport will be in excellent, safe running condition and will be kept in a neat and clean manner at all times. Upon objection from the Director to Company concerning the operation of such equipment or the unsafe and unclean condition of the equipment, Company will immediately remedy the cause of the objection. Company will immediately remove any equipment from the Airport that is not being actively used in Company's operations or that is not fully functional.
- 1.11.5 Company agrees that upon thirty (30) days advance written notice from the Director, Company will provide an inventory of all equipment used in the operation of Company's business at the Airport. Such inventory report shall include, but is not limited to: 1) where such equipment was obtained from, including all applicable serial and/or inventory numbers; 2) the dispensation of any equipment that was included on a previous report and that is no longer in service; 3) the date such equipment is placed in service and/or removed from service; and 4) any related inventory or serial numbers for such equipment.

1.12 METHOD OF OPERATION

- 1.12.1 Company agrees that it will employ and provide sufficient, qualified personnel to meet the needs of its customers to efficiently deliver the services authorized herein and to represent the highest level of customer service at the Airport. Such scheduling shall be made to ensure the operational needs of the Airport, as determined by the

Director, are met during all operational hours, including, but not limited to, peak operating hours, local special events, delays, or other similar emergencies that may arise from time to time.

- 1.12.2 Company will provide to Aviation a copy of any rules, regulations, or other standards of operation developed by Company, upon request from the Director.
- 1.12.3 Questions or complaints regarding the quality of services, merchandise, appearance of the Assigned Areas, employees, or Company's Agents, whether raised by users, general public, Aviation or otherwise, may be submitted to Company for response. At the DOA's request, Company shall meet with the Director to review any complaints or concerns and to correct any deficiencies promptly. The DOA's determination as to quality of operation, services, merchandise, appearance of the Assigned Areas, employees, or Company's Agents, shall be conclusive and curative measures shall be implemented by Company as expeditiously as possible. In the event that Company fails to respond to such complaints, or the continued violation of this Section, as determined by Aviation, may be considered a material breach of this Agreement and will be suitable grounds for termination as provided in Section 2.15 of this Agreement.
- 1.12.4 Company shall provide the highest quality of services for its customers and Airport tenants. All items purchased for the Company's operation must come from reliable sources. All items used in the Company's operation shall conform in all respects to any and all applicable federal, state, and local laws, ordinances, and regulations and industry standards. Failure on the part of Company to correct, modify or rectify any deficiencies within thirty (30) days, following written notice from Director, shall be a breach of this Agreement and a cause of the exercise of any remedies, including the termination of the Agreement as provided for in Section 2.15 of this Agreement.

1.13 CONTROL OF PERSONNEL

Company will, in and about the Assigned Areas and elsewhere upon the Airport, exercise reasonable control over the conduct, demeanor and appearance of Company's Agents and their conduct shall be in an orderly and proper manner so as not to annoy, disturb or be offensive to others. Company shall comply with all personnel requirements and standards set forth in Exhibit "B" attached hereto. Company shall not conduct business, solicit, or engage customers beyond the Assigned Areas. Company and Company's Agents shall, at all times while on duty, conduct themselves in a courteous manner toward the public and at all times act in accordance with the Airport Rules and Regulations and/or Airport Operating Directives. Upon objection from the Director to Company concerning the conduct, demeanor or appearance of such persons, Company will remedy the cause of the objection immediately or no later than two (2) business days. The Director will be the sole judge as to whether or not the conduct of the employees of the Company meets the requirements under this Agreement and, upon notice from the Director of any non-conformity. Company will take all steps necessary to eliminate the condition.

1.14 CONSTRUCTION OF TENANT IMPROVEMENTS

Company, at its sole cost and expense, except as otherwise provided herein, will perform all work required to complete the Assigned Areas to a finished condition. Commencement of Construction Improvements shall be diligently pursued by Company and shall be completed within one hundred twenty (120) days from the Approval Date, unless such date is extended by Aviation through written correspondence to Company.

1.14.1 Detail Plans

- A. Within sixty (60) days following issuance of a Tenant Improvement (TI) number by Aviation, or as otherwise approved by the Director, Company shall prepare detailed plans and specifications for the construction of the improvements to the Assigned Areas. Company shall include with its plans and specifications schematic renderings of the Assigned Areas, materials, color boards, and a detailed layout of required equipment. Approval by Director will extend to and include architectural and aesthetic matters and Director reserves the right to reject any designs submitted and to require Company to resubmit designs and layout proposals until they meet the approval of Director. Such approval shall not be unreasonably withheld.
- B. No changes or alterations will be made in said plans and specifications after approval by Director, and no structural alterations or improvements will be made to or upon the Assigned Areas without the written approval of Director. Director agrees to act promptly upon the plans and specifications and upon requests for approval of changes or alterations in said plans or specifications.
- C. Within thirty (30) calendar days upon completion of improvements and/or alterations of improvements, Company will provide to Aviation "as built" drawings of the Assigned Areas.
- D. Within sixty (60) calendar days upon completion of Improvements and/or alterations of Improvements, Company will provide to Aviation record drawings of the Assigned Areas.
- E. Company and/or Company's Agents must respond to comments made by Director within fifteen (15) days of receiving said comments.

1.14.2 Construction Period

Within fourteen (14) days following approval of the plans and specifications, Company will promptly seek all necessary licenses and permits for construction. Company will commence construction of Improvements in its Assigned Areas no later than thirty (30) days from the date of receipt from Aviation of all necessary

approvals. All improvement work will be subject to the inspection of Aviation and its authorized personnel.

Upon completion of Company's construction improvements, Director will conduct their own final inspection. The issuance of a Certificate of Occupancy by the Clark County Building Department will signify acceptance of the Assigned Areas by Aviation as having been built as required hereby.

1.15 CONSTRUCTION STANDARDS

- 1.15.1 Company will develop the Assigned Areas and cause to be constructed and maintain the Improvements in accordance with plans and specifications prepared by Company and approved by Director in order to provide a world-class aviation facility for use by passengers. Company agrees to operate its business at the Airport in a professional manner and keep its Assigned Areas in a safe, clean, and orderly condition at all times.

All Improvements or alterations to the Assigned Areas by Company will be at Company's sole cost and expense, and will be done in accordance with and subject to all applicable codes, the McCarran International Airport Tenant Improvement Manual, Airport Rules and Regulations, Operating Directives, and all other applicable governmental rules and regulations and building codes. All work will be performed in a workmanlike manner in accordance with all applicable governmental regulations and requirements and will not weaken or impair the structural strength or reduce the value of the Assigned Areas or Improvements.

All such improvements or alterations to the Assigned Areas are subject to the prior written approval of the Director as to plans, specifications, and methods of construction or installation. Immediately upon completion of any initial or additional construction, improvements, or alterations during the term hereof, Company will provide a complete set of as-built drawings of same to the Director along with a certification of construction costs for all permanent improvements, and a copy of the Temporary Certificate of Occupancy and the Certificate of Occupancy when received by Company.

Conceptual plans for such modifications and/or improvements are to be submitted to the office of the Department of Aviation, Business Office, via your assigned Contract Specialist, for Aviation's coordination and approval. All design and construction specifications and documents must be reviewed and approved by Aviation's Construction/Engineering Division prior to commencement of construction. Further, design and construction specifications and documents must be reviewed by Aviation and applicable Department of Building and Zoning having jurisdiction prior to the issuance of a building permit and will be subject to any statute, ordinance, rule or regulation of any other applicable governmental agency, department or authority whether federal, state or local, including, but not limited to, Nevada Revised Statutes

Chapter 338.

Company acknowledges that review of any plans, specifications or other documents by Aviation, the Director, or the Department of Aviation's Construction/Engineering Division pursuant to the foregoing terms shall not constitute a representation that such documents comply with the building code or other governmental requirements.

1.15.2 All Improvements constructed on the Assigned Areas by Company during the Term of this Agreement will be owned by Company. Aviation reserves the right to use the infrastructure, which benefit the Assigned Areas or other Airport related development without incurring cost other than that which would normally be associated with that use.

1.15.3 From time to time following the completion of the Improvements, Company may elect to construct subsequent Improvements in the area denoted on Exhibit A. Any such construction by Company shall be performed in compliance with the requirements of this Agreement.

1.16 WIRELESS APPLICATIONS AND SIMILAR TECHNOLOGIES

Company acknowledges that Aviation has and continues to install wireless capabilities for operational uses, in accordance with applicable Federal Communications Commission (FCC) regulations, rulings, and/or guidelines. Company agrees that it shall not install, deploy, or otherwise engage in the use of any transmitting wireless device, applications, and/or technologies on its Assigned Areas, any portion of the Airport or within the Airport System without first having obtained the express written permission of the Director. Such wireless applications shall only be for Company's operational use. Aviation reserves the right to impose a fee for the use of such wireless equipment or charge for any space required for the installation of such equipment, as additional rentals payable under this Agreement. Such wireless application shall only be for Company's operational use. Company shall not have any right to install any type of wireless device, application, or technology at the Airport for commercial or revenue generating purposes. Use by any others for the benefit of any other parties is specifically prohibited. At the request of Director, Company will cease operation of a particular device due to the interference with another transmitting device that is deemed necessary for operational and/or life-safety purposes.

1.17 NETWORK USAGE

1.17.1 Company will not be allowed to install any proprietary cabling and/or similar infrastructure at the Airport without prior written approval from the Director. As such, Company shall make use of Aviation's data communications backbone for its communications needs to connect separate operating locations within the Airport. Where authorized, at the discretion of the Director, any and all data communication cabling installed by Company shall be in accordance with Aviation's Tenant Improvement Manual requirements, and upon installation shall become the property

of Aviation, and shall be maintained by Aviation. Aviation may impose reasonable fees to Company for the use of such network, including, but not limited to, any fees for unusual and/or excessive or non-standard usage, as reasonably determined by Director.

- 1.17.2 Company will assign a representative(s), hereinafter “Authorized Network Representative,” to work with Aviation to determine user access and network connectivity information. Company shall be solely responsible for ensuring that Authorized Network Representative(s) are not security risks, and upon Aviation’s request, provide Aviation with information reasonably necessary for Aviation to evaluate any security event or incident relating to any Authorized Network Representative(s) or use of Aviation’s network.
- 1.17.3 Company shall be solely responsible for the selection, implementation, and maintenance of security procedures and policies that are sufficient to ensure that (i) Company’s use of Aviation’s network is secure and is used only for authorized purposes stated herein, and (ii) Company’s business information and data are protected against improper access, use, loss, disclosure, alterations, or destruction. Company agrees that it will not abuse or misuse the network connection, or any of the components thereof, or any of the capabilities provided. Unless otherwise explicitly provided herein, in no event shall Company use the network connection as its internet service provider.
- 1.17.4 Company shall notify Aviation’s Information Systems as soon as possible upon the discovery of any security breach or potential security breach that may affect Company or Aviation’s confidential information or the security of the network or any network connection.
- 1.17.5 Company shall ensure adequate security protection for Aviation from any third party connections established on Company’s network. Adequate security protection means (i) protection to preserve confidentiality, integrity, and availability of the network and information of Aviation, and (ii) protection from malicious codes and/or unauthorized intrusions.
- 1.17.6 Company and Aviation shall be responsible for maintaining the highest industry standards for security best practices on computing devices that could affect the availability and health of the network connection, the network, systems, applications or data of Company and Aviation, specifically including, but not limited to, use of up-to-date anti-virus protection, anti-SPAM, and establishment of use of a timely security patch management process.

1.18 NOTICES

All notices, requests, consents and approvals under this Agreement will be served or given by certified mail, registered mail, (to the P.O. Box listed below), nationally recognized courier

(such as FedEx or UPS) (to the street address listed below), or email, except in cases of emergency, in which case it will be confirmed by email. All communication via email or facsimile will be confirmed by a response email or facsimile or automated confirmation method. Any changes to the contact information contained herein will be exchanged in writing.

1.18.1 **Notices to Aviation:** Notices intended for Aviation sent via certified or registered mail, will be addressed to:

Clark County, Nevada
Attn: Director of Aviation
P.O. Box 11005, Airport Station
Las Vegas, Nevada 89111-1005
FAX: (702) 261-5050

Notices intended for Aviation sent via nationally recognized courier (such as FedEx or UPS), will be addressed to:

McCarran International Airport
Attn: Business Office
2nd Floor – Central Services
5757 Wayne Newton Boulevard
Las Vegas, Nevada 89119

Notices intended for Aviation sent via email, will be addressed to:

E-Mail: Concessions@mccarran.com

or to such other address as may be designated by Aviation by written notice to Company.

1.18.2 **Notices to Company:** Notices intended for Company via certified or registered mail, or via nationally recognized courier (such as FedEx or UPS), will be addressed to:

University Medical Center of Southern Nevada
Attn: Contracts Management
1800 W. Charleston Boulevard
Las Vegas, Nevada 89102
Phone: 702-383-2785

Notices intended for Company sent via email, will be addressed to:

E-Mail: Shana.Tello@umcsn.com

or to such other address as may be designated by Company by written notice to Aviation.

ARTICLE II

2.1 ASSIGNMENT

Company shall not assign, mortgage or encumber this Agreement, or sublet or permit the Assigned Area or any part thereof to be used or occupied by others, without the prior written consent of Aviation in each instance, which consent will not be unreasonably withheld, and any such assignment, mortgage, encumbrance, sublease or permission without such consent shall be voidable at the option of Aviation and, at the option of Aviation, shall terminate this Agreement.

- 2.1.1 Regardless of Aviation's consent, no assignment will release Company of Company's obligation that accrued or matured under this Agreement prior to the assignment.
- 2.1.2 The acceptance of rent by Aviation from any other person will not be deemed to be a waiver by Aviation of any provision hereof.
- 2.1.3 Consent to one assignment will not be deemed as consent to any subsequent assignment.

2.2 SUBLEASING

Notwithstanding anything to the contrary contained in this Agreement, subleases are not allowed under this Agreement. Company shall not sublease, rent or permit any persons, firms or corporations to occupy any part of the Assigned Areas or to provide any type of commercial operation from the Assigned Areas. Company's allowance of certain specialty contractors which do not permanently, including but not limited to Lab Corp. To provide Services in the Assigned Areas shall not constitute a sublease under this section.

2.3 SUCCESSORS AND ASSIGNS

This Agreement shall be binding upon and shall inure to the benefit of the parties hereto and its respective heirs, personal representatives, successors, or assigns, as the case may be. All covenants and conditions of this Agreement will extend to and bind the legal representatives, successors, and assigns of the respective parties thereto and all agreements with assignees or sublessees will include all provisions contained in this Agreement.

2.4 SIGNS AND/OR WORKS OF ART

- 2.4.1 Company will not erect, install, operate, nor cause or permit to be erected, installed, or operated upon Airport property, except as provided below, any signs or other similar advertising devices for its own business.
- 2.4.2 Any identifying signs erected, installed, operated or attached to the Assigned Areas will require the prior written approval of the Director. Such written consent may

consider factors, including but not limited to, size, type, content, and method of installation. Such signs shall relate solely to advertising the authorized uses as described in Section 1.4.

- 2.4.3 Company will not commission, install or display third party advertising without the prior written approval of the Director. Such advertising shall be subject to standard airport advertising fee schedule and shall be in conformance with the Airport Advertising Policy.
- 2.4.4 Company will not commission, install or display any work of art without the prior written approval of the Director and without a full written waiver by the artist of all rights under the Visual Artist's Rights Act of 1990, 17 U.S.C. (Sections 106A and 113).

2.5 ENTRY AND INSPECTION OF ASSIGNED AREAS

Aviation, its authorized officers, employees, agents, contractors, subcontractors or other representatives will have the right to enter upon the Assigned Areas for the following reasons, by providing at least two (2) business days prior written notice and while accompanied by a representative of Company, except in an emergency, in which case Aviation will specify the nature of the emergency and the need for immediate entry; however, Aviation shall not have access nor right of entry at any time to any of Company's patient examination rooms, without the approval of Company, which approval shall not be unreasonably withheld except in the event a patient is occupying said examination room.:

- 2.5.1 To inspect at reasonable intervals during regular business hours (or any time in case of emergency) to determine whether Company has complied and is complying with the terms and conditions of this Agreement.
- 2.5.2 For the purpose of inspecting the Assigned Areas and for fulfilling Aviation's obligations hereunder, provided however, that such entry will be at such times and in such manner as to not unreasonably interfere with the operations of Company. Aviation may, however, enter at any time for emergency repairs or maintenance without responsibility to Company for loss of business.

No such entry by or on behalf of Aviation upon these Assigned Areas will cause or constitute a termination of this Agreement nor be deemed to constitute an interference with the possession thereof nor constitute a revocation of or interference with any of Company's rights in respect thereof for exclusive use of the Assigned Areas.

The inspections contemplated by the parties to this Agreement, pursuant to this Section, are for the sole benefit of the parties. No benefit to any third party is contemplated nor intended.

Aviation agrees that Company may lock and deny access to areas of the Assigned Areas that contain Protected Health Information ("PHI"), as that term is defined by

the Health Insurance Portability and Accountability Act of 1996 (“HIPAA”) and its associated regulations, as amended from time to time.

2.6 INTENTION OF PARTIES

This Agreement is intended solely for the benefit of Aviation and Company and is not intended to benefit, either directly or indirectly, any third party or member(s) of the public at large. Any work done or inspection of the Assigned Areas by Aviation is solely for the benefit of Aviation and Company.

Nothing contained herein shall be deemed or construed by the parties hereto, or by any third party, as creating a relationship other than the relationship of Aviation and Company.

2.7 LIENS

2.7.1 Company and Company’s Agents shall take or cause to be taken all steps that are required or permitted by law in order to avoid the imposition of any lien upon the Assigned Areas, any Improvements, or equipment, or any other portion of the Airport. Should Company or any subtenant cause any Improvements to the Assigned Areas, Company shall cause any contract with any contractor, designer, or other person providing work, labor, or materials to the Assigned Areas to include the following clause:

“Contractor agrees on behalf of itself, its subcontractors, suppliers, and consultants and its respective employees, that there is no legal right to file a lien upon County-owned property, and will not file a mechanic’s lien or otherwise assert any claim against the County’s real estate or any leasehold interest thereon on account of any work done, labor performed or materials furnished under this contract. Contractor agrees to indemnify, defend and hold the County harmless from any liens filed upon the County’s property and Company’s leasehold interest and shall promptly take all necessary legal action to ensure the removal of any such lien at Contractor’s sole cost.”

2.7.2 However, should any lien be placed on the Assigned Areas, any Improvements, or equipment, Company will cause to be removed any and all liens of any nature including, but not limited to, tax liens and liens arising out of or because of any construction or installation performed by or on behalf of Company or any of its contractors or subcontractors upon Company’s Assigned Areas or arising out of or because of the performance of any work or labor to it or them at said Assigned Areas or the furnishing of any materials to it or them for use at said Assigned Areas. Should any such lien be made or filed, Company will bond against or discharge the same within thirty (30) days after written request by the Director.

2.7.3 Company agrees to defend and hold Aviation harmless from any liens filed upon Aviation’s property and shall promptly take all necessary legal action to ensure the removal of any such lien at Company’s sole cost.

2.7.3 Pursuant to NRS §108.234, Aviation hereby informs Company that Company must comply with the requirements of NRS §108.2403 and NRS §108.2407. Company shall prepare and deliver to Aviation, a Notice of Non Responsibility as required by NRS Chapter 108. Company shall post in a conspicuous location at the Assigned Areas a Notice of Non Responsibility for the benefit of Aviation. Company's contractors may not enter the Assigned Areas to begin construction of any Improvements, or preparation for the same, until Company has delivered evidence satisfactory to Aviation that Company has complied with the terms of this Section and NRS Chapter 108.

2.7.4 Failure by Company to comply with the terms of this Section shall permit Aviation to declare Company in default hereunder. The provisions of this Section shall survive the expiration or earlier termination of this Agreement.

2.8 RULES AND REGULATIONS

Company hereby agrees to be bound in the operation of its service at the Airport by all applicable Airport rules and regulations ("Rules and Regulations"), including, but not limited to, the Airport Tenant Improvement Manual, Operating Directives, Airport Environmental Compliance Handbook, Nevada Revised Statutes, County Ordinances or other such governmental regulations, whether municipal, state or federal, including, but not limited to, all environmental laws, and will immediately, upon request, verify compliance to any such requirement. Company must adhere to the Airport Rules and Regulations, as amended from time to time. Company agrees to be subject to any fines resulting from violations of any Rules and Regulations. Company will keep current municipal, state or federal licenses or permits required for the conduct of its business, if any.

2.9 AIRPORT SECURITY

Company covenants that it will, at all times, maintain the integrity of the Airport Master Security Plan and Transportation Security Administration ("TSA") Regulations (TSA) currently in effect or as may be implemented or modified from time to time, and that it will always maintain the security of the Airport and/or any access which Company maintains. Company also hereby agrees that it shall also be responsible for any and all actions of its employees, subcontractors, suppliers, agents, and/or representatives, and shall provide any and all necessary escorts as outlined in the Airport's Master Security Plan, at all times. Company covenants that it will always maintain the security of any airfield access which Company maintains. Should Company allow unauthorized access to the Airport Operations or Security Area, and/or should Aviation be cited for a civil penalty, Company agrees to reimburse Aviation for any monetary civil penalty which may be imposed by the Federal Aviation Administration, the TSA, or any appropriate agency.

2.9.1 Airport Security Program

Company shall be responsible for obtaining and coordinating any (TSA) required and Aviation administered criminal history record checks, security threat assessments, badging, vehicle decals, and/or other activities required to ensure their agents, employees, vendors, suppliers, service providers, directors, or officers are in compliance with the Airport's Security Program, Title 20 Ordinance, TSA Regulations 49 CFR Parts 1500, 1520, 1540, 1542, 1544, 1546, 1548, and 1550, as promulgated, and the terms and conditions of this Agreement.

2.9.2 Background Checks

Company shall be responsible for the proper certification and background checks for all its employees, agents, vendors, suppliers, service providers, contractors, subcontractors, officers, and directors for which it requests and/or obtains an Airport Security Badge. Such certifications include those in support of TSA required criminal history record checks, and security threat assessments. In the event Company, or any of its employees, agents, vendors, suppliers, service providers, contractors, subcontractors, officers, and directors fails in its responsibilities for proper certifications, background checks or to return such Airport-issued badges upon cessation of employment or other circumstances, as described in above paragraph, and/or any cause of action that either singularly or collectively would require Aviation to be in violation of TSA Regulations, Aviation's TSA-approved Airport Security Program (to include re-badging of all Airport personnel) and applicable Part 1542 security directives, Company shall solely bear the total cost of such TSA-issued monetary civil penalties and/or the re-badging process.

2.9.3 Security Regulations

Company covenants that it will at all times preserve the integrity of the Airport's Security Program and TSA Regulations 49CFR Part 1500, 1520, 1540, 1542, 1544, 1546, 1548, and 1550, as promulgated, and that it will always preserve the security of any Secure Area/SIDA access which Company maintains. Company agrees that it shall be responsible for any and all of the actions of its employees, subcontractors, suppliers, agents, and/or representatives and shall provide any and all escorts, as outlined in the Airport's Security Program, at all times. Company agrees that it shall be responsible for ensuring its employees, subcontractors, suppliers, agents, and/or representatives shall adhere to all Airport and TSA security policies, procedures and rules.

2.9.4 Compliance

Should Company, its employees, subcontractors, suppliers, agents, and/or representatives cause any TSA Letter-of-Investigation (LOI) or TSA monetary civil penalty to be assessed against Aviation, Company agrees to reimburse Aviation for

all costs which may be imposed by TSA. Company may have badge/access privileges immediately suspended and/or revoked by the Director of Aviation or designee for failure to adhere to the Airport Security Program or for failure to return all badges within the time frames specified herein. In the event of a severe incident, such actions may also result in the immediate suspension and/or termination of this Agreement, at the sole discretion of the Director.

2.9.5 Badging

In accordance with the Airport Security Program, Company must obtain Airport security badging and fingerprinting for its eligible employees, contractors, subcontractors, suppliers, agents, and representatives, and pay any and all related costs associated with this privilege as defined in Section 1.5.5.

Said badges are the property of Aviation and expire annually, at 11:59 PM on the date of the badge holder's birthday or other time as specified by the Director. Badges, if lost, must be immediately reported to Aviation. During normal business hours, such reports must be made to the Airport Badging Office at (702) 261-5652. Outside of normal business hours, lost badge reports must be made to the Airport Control Center at (702) 261-5125.

If the badge holder's Airport access is deactivated due to badge expiration, termination, suspension and/or other cessation of employment and/or termination of this Agreement, or such other terms as may be designated by the Director, Company must immediately report such information to Aviation, via the contact entities and phone numbers provided above. Company is responsible for ensuring all Airport-issued badges are returned to Aviation for any circumstances as described above.

2.10 AIRPORT PERSONNEL IDENTIFICATION

All personnel requiring access to the Airport Terminal Buildings or Airport Operations Area will be required to obtain identification and clearance issued at the sole discretion of Director, and in accordance with Airport Rules and Regulations Code, and the most current Airport Master Security Plan. Company covenants that it will at all times maintain the integrity of the Airport Master Security Plan – FAR Part 107 and the Automated Access Control System. Company agrees to obtain Airport badging for its employees and representatives, and pay any and all related costs associated with this requirement. Said badges will only be valid for the term of this Agreement and must be returned to the Airport Badging Office within twenty-four (24) hours or the next business day after expiration or suspension and/or termination of this Agreement. Company is responsible to return the badges of employees and representatives that are no longer employed by Company. Company agrees to pay any associated fees and/or penalties for all badges not returned within this time frame. Company will be required to comply with all security requirements currently in effect or as may be implemented from time to time, including but not limited to background checks for each badge requested.

Company hereby agrees that it shall also be responsible for conducting and verifying any and all required background checks, and for badging for any and all of its employees, subcontractors, suppliers, agents, and/or representatives.

Company will be required to have each employee continuously display any issued Airport security badge while on Airport property. Failure to do so will result in the immediate suspension and/or termination of the badge access and this Agreement.

Company will have some or all badge/access privileges immediately suspended and/or revoked as appropriate in the sole discretion of the Airport Security Administrator for failure to adhere to the Airport Security Plan or for failure to return all badges within the time frames specified herein, and fined as provided under Airport Rules and Regulations. Such actions may also result in the immediate termination of this Agreement, at the sole discretion of Aviation.

2.11 INGRESS AND EGRESS AND VEHICLE PARKING

Company will have the non-exclusive right, in common with other Airport tenants and the general public, for ingress and egress to the Airport.

Company will not have the right to free parking of vehicles in the Airport's public parking areas for Company, its employees, agents, representatives, clients, customers, contractors, or subcontractors.

Up to 22 badged fulltime, part time and subcontracted employees may park for free in the employee parking area. Additional badges will be subject to employee parking fees.

2.12 TAXES, LICENSES, AND PERMITS

Company must, at its own expense, identify, provide to Aviation and maintain in force, any and all licenses and permits required for the legal operation of all aspects of this Agreement. Company will promptly pay all applicable taxes, excises, license fees and permit fees of whatever nature applicable to its operation and lease of Assigned Areas hereunder. Company may elect, however, at its own cost and expense to contest any such tax, excise, levy or assessment. Company will keep current federal, state, municipal or local licenses or permits required for the conduct of its business. Company will pay before delinquency all taxes, excises, license fees and permit fees of whatever nature applicable to the Assigned Areas, the Improvements and Company's personal property, including, but not limited to, real property taxes. Company shall not be responsible for any of County's franchise, inheritance, income or other tax levied on County or County's right to receive income from the Assigned Areas. Notwithstanding anything herein to the contrary, Company will promptly pay all taxes if at any time the Assigned Areas or any part thereof will otherwise be immediately subject to forfeiture, foreclosure or other similar proceedings. Company agrees to hold Aviation harmless from any and all loss, cost, damage, expense, penalty or any liability whatsoever

resulting from or in any manner arising out of the delay or failure of Company to pay when due, discharge or comply with any such taxes or other governmental charge. The provisions of this Section shall survive the expiration or earlier termination of this Agreement.

2.13 *Intentionally deleted. INDEMNITY*

2.14. DISCLAIMER OF LIABILITY.

Aviation hereby disclaims any and all liability whether in contract or tort (including strict liability and negligence) for any loss, damage or injury of any nature whatsoever sustained by tenant, its employees, agents or invites during the term of this agreement, including but not limited to loss, damage or injury to the property of tenant that may be located or stored on the Assigned Areas, unless such loss, damage or injury is caused by aviation's gross negligence or intentional willful misconduct, the parties hereby agree that under no circumstances shall either Party be liable for indirect, consequential, special or exemplary damages, whether in contract or tort (including strict liability and negligence).

2.15 INSURANCE AND CONSTRUCTION BONDS

Company will ensure that all insurance and construction bonds as required herein are provided and maintained by the Company, its contractors, sublessees, or other parties who develop any portion of the Assigned Areas. As used in this Section 2.14, any reference to Company shall be deemed to include Company's contractors, sublessees, or other parties involved in the development and/or potential lease of the Assigned Areas, as applicable.

2.15.1 Insurance Requirements: Upon Company's execution of this Agreement and during the entire term of this Agreement, Company agrees to furnish and maintain satisfactory evidence of insurance as required herein or as may be identified in Clark County Code, Title 20, **whichever is greater**. All required coverages shall be evidenced by a current certificate of insurance. Prior to the commencement of any Improvements or equipment installation on or about the Assigned Areas, Company will require that its construction contractor and all sublessees (including any entity providing Commercial Aviation Activities) procure and maintain insurance naming both Company and County as an insured. Each contractor and subcontractor shall procure and maintain until all of their obligations, including any warranty periods under this Agreement are satisfied, insurance against claims for injury to persons or damage to property which may arise from or in connection with the performance of the work by the contractor, its agents, representatives, employees or subcontractors. The coverage and limits shall be (1) the minimum coverage and limits specified in this Agreement; or (2) the broader coverage and maximum limits of the coverage available to the named insured, whichever is greater. Such insurance will include, as applicable, but is not limited to, the following:

- A. **Comprehensive Commercial General Liability Insurance** coverage for claims of property damage, personal injury, bodily injury or death allegedly

resulting from Company's activities into, on, or leaving any part of the Airport, in an amount not less than One Million (\$1,000,000) Dollars, per person, per occurrence combined single limit, minimum aggregate, if any of Two Million (\$2,000,000) Dollars.

- B. **Automobile Liability Insurance** in an amount not less than [FOR NON-AOA ACCESS: One Million (\$1,000,000) Dollars, per occurrence, combined single limit.] [FOR AOA ACCESS: Five Million (\$5,000,000) Dollars, per occurrence, combined single limit.]
- C. **Worker's Compensation Insurance** in the amounts and form as required by the Nevada Industrial Insurance Act and the Nevada Occupational Diseases Act. Certificates evidencing the valid, effective insurance policies will be provided to and kept on file with the Director.
- D. **Property Insurance Coverage** with responsible insurance underwriters any and all Improvements constructed by it upon and within the Assigned Areas, including all personal property contained therein, to the extent of not less than one hundred percent (100%) of the Full Insurable Replacement Value of such Improvements, including property and personal property using the all-risk form of protection as acceptable to the Director. Company will be responsible for insuring against any rental protection resulting in loss of income, personal property or extra expense to Company.
- E. **Builder's Risk** if applicable, Company will provide coverage that insures that any Improvements constructed by it upon and within the Assigned Areas to the extent of not less than one hundred percent (100%) of such Improvements full insurable value using the all-risk form of protection as acceptable to Aviation. Company will be responsible for insuring against any business interruption resulting in loss of income or extra expense to Company. Company shall obtain and maintain flood insurance required hereunder in such amounts and forms as are available, from time to time, under the National Flood Insurance Program.

2.15.2 Company's (or Company's Agents) insurance will be primary as respects Aviation and Company, its officers, employees and volunteers acting as agents of Aviation, hereinafter referred to as "volunteers." Any other coverage available to Aviation, its officers, employees and volunteers will be excess over the insurance required by the contract and shall not contribute with it.

2.15.3 **Certificates of Insurance:** Company shall provide Aviation evidence of required minimum insurance coverage and endorsements, as noted above, within fifteen (15) calendar days from the date of written approval by Aviation. Such Certificates of Insurance will include, but will not be limited to, the following:

- A. **Additional Insured:** Clark County, Nevada, its elected officers, appointed executives or other officers, other employees, agents, volunteers, members of boards, and Commissioners of County of Clark shall be named as additional insured on the above policies (with the exception of employer's liability) to the full limits of liability purchased by Company even if those limits of liability are in excess of those required by this Agreement. Copies of such certificates are to be provided to the Director. All property insurance policies will contain a waiver of subrogation clause in favor of Clark County.
- B. **Endorsements:** All additional insured endorsements shall be included with the Certificate of Insurance. Required endorsements are additional insured endorsements, primary noncontributory, and waivers of subrogation. Each insurance policy supplied by the Company or Company's agents, must be endorsed to provide that the coverage will not be suspended, voided, or canceled or reduced in coverage or in limits except after thirty (30) days prior written notice to Aviation by mail. This notice does not waive the insurance requirements contained herein.
- C. **Aggregate Limits:** If aggregate limits are imposed on the insurance coverage, then the amounts of such limits must not be less than Two Million Dollars (\$2,000,000) per occurrence. All aggregates must be fully disclosed and the amount entered on the required Certificate of Insurance. The "per occurrence" limits of insurance required herein must be maintained in full, irrespective of any erosion of aggregate. A modification of the aggregation limitation may be permitted if it is deemed necessary and approved by the Director and Company.
- D. **Best's Key Rating:** The rating of the insurance company's financial strength shall be "A- VIII" or stronger, as published in the latest Best's Key Rating Guide.
- E. **Deductibles/Self-Insured Retention:** All deductibles and self-insured retention shall be fully disclosed within the Certificates of Insurance. No deductible or self-insured retention may exceed Twenty-five Thousand Dollars (\$25,000) unless the Director gives prior written consent.
- F. **30 Day Notice:** Certificates of Insurance will provide a thirty (30) day written notice provision for cancellation or coverage reduced of any policy.
- G. **Agent:** The Certificate shall be signed by a carrier approved to write insurance in the State of Nevada.
- H. **Renewal Certificates:** All renewal insurance certificates must be provided to Aviation prior to the expiration of the current insurance.

- 2.15.4 Company is responsible for and must remedy all damage or loss to any property, including property of Aviation, caused in whole or in part by Company, its contractors, any subcontractor or anyone employed, directed or supervised by Company.
- 2.15.5 If Company (or its contractors) fails to maintain any of the insurance requirements or coverage herein, then Aviation will have the option of 1) declaring Company in breach of this Agreement under this paragraph; or 2) purchase replacement insurance or pay the premiums that are due on existing policies in order that the required coverage is maintained. Company is responsible for any expenses paid by Aviation, plus a twenty (20%) administrative fee, to maintain such insurance and Aviation may collect the same from Company.
- 2.15.6 If at any time Aviation decides to implement option 2 of Section 2.15.5 above, the Director will advise Company within ten (10) days' notice of Aviation's intention to purchase such insurance for Company's account. If Company has not delivered evidence of insurance to Aviation before the date on which the current insurance expires, Aviation will provide such insurance by taking out policies in companies satisfactory to Aviation. Such insurance shall be in amounts no greater than those stipulated herein or as may be in effect from time to time. The amount of premiums paid by Aviation for such insurance shall be payable by Company immediately upon receipt of Aviation's invoice therefore, with interest at a rate of twenty percent (20%) per year, accrued and compounded on a monthly basis, commencing at the date of payment by Aviation.
- 2.15.7 Company is responsible for initiating, maintaining, and supervising all safety precautions and programs in connection with this Agreement. Company shall keep in proper functioning order all firefighting equipment in the Assigned Areas, excluding Aviation's automated sprinkler system.
- 2.15.8 Aviation shall have the right from time to time, on not less than ten (10) days' notice, to require Company to increase the amount or type of coverage required to be maintained under this Agreement.
- 2.15.9 The insurance requirements specified herein do not relieve the Company of its responsibility or limit the amount of its liability to Aviation or other persons and Company is encouraged to purchase such additional insurance as it deems necessary.
- 2.15.10 **Construction Bond Requirements:** Prior to the commencement of any construction or installation of any Improvements, Company shall provide to Aviation all applicable construction bonds as required herein including the following.
- A. Company and its contractors shall provide and maintain close-out deposits, construction bonds or establish a construction disbursement account in accordance with NRS 108.2403 and the Airport Tenant Improvement

Manual. Company will provide such bonds to Aviation no later than ten (10) calendar days after notification of award of any construction contract.

- B. Company will require its contractor to require the attorney-in-fact who executes the required Bonds on behalf of the Surety to affix thereto a certified and current copy of his power of attorney.
- C. Bonds may be secured through the Contractor's usual sources provided the Surety is authorized and licensed to do business in the State of Nevada.

2.15.11 Aviation retains the right to adjust insurance and bond requirement limits, as may be necessary to insure against the risk for a specific activity requested by Company and submitted to Aviation for approval. Such limits shall not exceed those limits established for similar activities at the Airport. Company shall require that all policies meet the requirements as set forth in this Section 2.15 of the Agreement or under any sublease agreement with Company.

2.16 TERMINATION BY AVIATION

2.16.1 **Default by Company:** Company will be considered in default under this Agreement in the event of any one or more of the following occurrences:

- A. Company fails to either Commence Construction or to complete construction of the Improvements as further outlined in Section 1.14 of this Agreement.
- B. Company becomes insolvent, or takes the benefit of any present or future insolvency statute, or makes a general assignment for the benefit of creditors, or files a voluntary petition in bankruptcy, or a petition or answer seeking an arrangement for its reorganization, or the readjustment of its indebtedness under the Federal bankruptcy laws, or under any other law or statute of the United States or of any State, or consents to the appointment of a receiver, trustee, or liquidator of any or substantially all of its property.
- C. A petition or the liquidation under Federal bankruptcy statutes or action under any present or future insolvency law or statute is filed against Company and is not dismissed within sixty (60) days after the filing or which causes the discontinuance of the fulfillment of any required provision of this Agreement by Company.
- D. Company fails to pay the rental charges or other money payments required by this Agreement when the same are due and the continuance of such failure for a period of ten (10) business days after written notice from the Director to Company.
- E. Company has received three (3) default notices from Aviation for any default

under this Agreement within a twelve (12) month period, regardless of the reason for such default notice and whether or not such default was cured by Company.

- F. Company voluntarily abandons any of the Assigned Areas leased or assigned to it or discontinues the conduct and operation of any businesses at the Assigned Areas or ceases to provide any or all of the services as required under this Agreement.
- G. Any violation by Company of the terms and conditions of this Agreement. If such default is not cured, as provided for in Section 2.15.3 of this Agreement, Aviation may, at its sole discretion, suspend or terminate this Agreement.
- H. If Company shall fail to abide by all applicable federal, state, and local laws, ordinances, rules and regulations.
- I. If Company shall fail to take possession of the Assigned Areas as defined in Section 1.14.
- J. Company fails to keep all insurance policies in effect, as required under Section 2.15, of this Agreement, until the time it surrenders its Assigned Areas.
- K. Company fails to remove unauthorized items as identified in Section 1.4.5 as required by this Agreement and when such failure continues for a period of five (5) days after written notice to Company.
- L. Company fails to comply with the performance standards set forth in Section 1.4.8 of this Agreement.

2.16.2 **General Provisions:** All rights and remedies of Aviation herein created or otherwise existing at law are cumulative, and the exercise of one or more rights or remedies shall not be taken to exclude or waive the right to exercise of any other. All such rights and remedies may be exercised and enforced concurrently and whenever and as often as deemed advisable.

2.16.3 **Cure:** Company will be considered in default of this Agreement as set forth in Section 2.16.1, and if such failure continues for a period of more than thirty (30) days (except for failure to pay rental charges as described in Section 2.16.1(D) or for failure to remove unauthorized items as described in Section 2.16.1(K)) after delivery by the Director of written notice of such breach or default, except if the fulfillment of Company's obligations requires activity over a period of time, then Company must commence in good faith to perform whatever may be required for fulfillment within ten (10) days after receipt of notice and continue such performance without interruption except for causes beyond its control. Upon receiving a third notice of

default from Aviation within a twelve (12) month period as provided in Section 2.16.1(E), Aviation at its sole discretion may not allow Company to cure the default set forth in the third and final notice of default, and the Agreement may be terminated as provided in Section 2.16.4. Aviation may elect to terminate this Agreement with thirty (30) days' written notice to Company and may exercise all other rights and remedies at law or in equity.

2.16.4 Termination for Default by Company: In addition to all other remedies available, if default is made by Company as described in Section 2.16.1 herein above, and such default is not cured as provided in Section 2.16.3, or Company has received three (3) default notices from Aviation for any default under this Agreement within a twelve (12) month period as provided in Section 2.16.1(E) and Section 2.16.3, Aviation may elect to terminate this Agreement with thirty (30) days' written notice to Company and may exercise all other rights and remedies at law or in equity.

- A. If Aviation elects to terminate this Agreement, Aviation shall retain all rights and remedies at law or in equity, and such termination will in no way prejudice the right of action for rental arrearages owed by Company.
- B. In the event of any termination for default by Company, Aviation will have the right to enter upon the Assigned Areas and take possession of same. Redelivery and Disposal of Improvements will be as described in Section 2.21 of this Agreement.

2.17 TERMINATION BY COMPANY

2.17.1 Default By Aviation: Aviation will be considered in default of this Agreement if Aviation fails to fulfill its obligations set forth in this Agreement, and if such failure shall continue for a period of more than thirty (30) days after delivery by Company of a written notice of such material breach.

2.17.2 Cancellation: As the sole remedy, this Agreement shall be subject to cancellation by Company should any one or more of the following conditions occur:

- A. The abandonment of the Airport, or any portion, for longer than six (6) months.
- B. The assumption by the United States government, or any authorized agency, of the operation, control or use of the Airport or any portion and its facilities in such a manner as to substantially restrict Company from installing and maintaining its Assigned Areas and associated operations, if such restriction be continued for a period of three (3) months or more.
- C. Aviation's redetermination of rents and fees as set forth in Section 1.5.7 of this Agreement.

2.17.3 **Cure:** Aviation will not, however, be considered in breach of this Agreement if the fulfillment of its obligation requires activity over a period of time and Aviation has commenced in good faith to perform whatever may be required for fulfillment within thirty (30) days after receipt of notice and continues such performance without interruption except for causes beyond its control.

2.17.4 **Termination For Default By Aviation:** If a material breach is made by Aviation as described in Section 2.16.1 herein above, Company may elect to terminate this Agreement with thirty (30) days written notice to the Director.

A. In the event of the termination for default by Aviation, Redelivery and Disposal of Improvements will be as described in Section 2.21 of this Agreement.

B. In the event of any termination for default by Aviation, it will in no way prejudice the right of action for rental arrearages owed by Company.

C. In the event of any termination for default by Aviation, Company shall not be entitled to any damages arising out of or in connection with any such termination of this Agreement, including loss of business, loss of revenue, loss of profit, or any damages resulting from any breach by Aviation of this Agreement.

2.17.5 **Termination for Convenience:** Both Parties shall have the right to terminate the Agreement during the Term, upon notification to the non-terminating Party in writing of the terminating Party's intention to terminate no later than ninety (90) days prior to any annual renewal of the Agreement Term.

2.18 WAIVERS AND ACCEPTANCE OF FEES

2.19.1 No waiver of default by either party hereto of any of the terms, covenants or conditions hereof to be performed, kept or observed will be construed to be or act as a waiver of any subsequent default of any of the terms, covenants, conditions herein contained to be performed, kept and observed.

2.19.2 No acceptance of fees or other money payments in whole or in part for any period or periods during or after default of any of the terms, conditions or covenants to be performed, kept or observed by Company will be deemed a waiver on the part of Aviation of its right to terminate this Agreement on account of such default.

2.19 FIRE PROTECTION

From time to time and as often as reasonably required by Aviation, Company will conduct appropriate tests of any fire extinguishing apparatus located on the Assigned Areas.

Company will keep in proper functioning order all firefighting equipment located on the Assigned Areas.

2.20 DAMAGE AND DESTRUCTION

In the event of damage, destruction, or substantial loss which materially impairs Company's ability to operate upon the Assigned Areas, by any cause, which damage, destruction or loss is not capable of being repaired within sixty (60) days, Company will have the option to terminate this Agreement which option will be exercisable by written notice to Aviation within thirty (30) days after the occurrence of such event. In the event Company elects to terminate this Agreement based upon such damage, destruction, or substantial loss and Company or its employees or agents cause such damage, destruction or substantial loss to occur, Company will be liable for and will pay for all cleanup or demolition necessary to make the Assigned Areas ready for repair, replacement, restoration or rebuilding, including the removal and/or replacement of personal property, which is not otherwise covered by insurance. In the event Company does not exercise such option, or in the event said damage, destruction or loss is capable of being repaired within sixty (60) days, then Company will promptly repair, replace, restore or rebuild said Improvements and/or personal property.

2.21 REDELIVERY AND DISPOSAL OF IMPROVEMENTS AT TERMINATION

2.21.1 Company covenants that at the termination of this Agreement, howsoever caused, it will quit and surrender such Assigned Areas in good repair and condition, excepting reasonable wear and tear, acts of God, the public enemy or the action of the elements.

2.21.2 Upon termination of this Agreement howsoever caused, Aviation will require Company to remove from the Assigned Areas, and other applicable areas of the Airport, within thirty (30) days of termination, all equipment, trade fixtures and personal property belonging to Company.

A. For purposes of this Section, the words "equipment, trade fixtures and personal property" will include, but not be limited to, signs (electrical or otherwise) used to advertise or identify Company's business, all equipment used in connection with the conduct of its business whether or not such equipment is attached to said Assigned Areas; any other mechanical device; and all other miscellaneous equipment, furnishings and fixtures installed on or placed on or about the Assigned Areas and used in connection with Company's business thereon.

2.21.3 Upon termination of this Agreement, howsoever caused, Aviation will have the option to require any of the following by giving written notice prior to the date of termination, as determined by the Director to be in Aviation's best interest.

Company will, upon receipt from Aviation of thirty (30) days' notice of termination, remove all or part (as determined by the Director) of the permanent Improvements

made to or placed upon the Assigned Areas by Company. Company agrees that it will use due diligence in completion the removal as may be required herein.

- A. Company will leave in place all of the permanent Improvements whereupon title and ownership will pass from Company and vest in Aviation without any further consideration required from Aviation. Company agrees that it will immediately provide any transfers of title to Aviation as may be required.

For purposes of this Section, the words “permanent Improvements,” means all Improvements and fixtures installed by Company upon the Assigned Areas which will include, but not be limited to lighting, fencing, buildings, structures and related appurtenances, wall coverings, carpeting, draperies and light fixtures unless this Agreement expressly requires Aviation to pay Company for the unamortized value of the Improvements.

Company shall restore the Assigned Areas to its original condition, reasonable wear and tear excepted, as directed by Aviation. Company shall complete restoration within ninety (90) days, or such other time acceptable by Aviation, and work shall be done in accordance with the Airport Tenant Improvement Manual. All such restoration work shall be at the sole cost and expense of Company.

- 2.21.4 All material items, whether owned by Company or are in Company’s custody and control, shall be removed from the Assigned Areas or other applicable areas of the Airport. Any material items left behind by, or on behalf of Company shall be considered abandoned and shall be disposed of accordingly at the sole cost of Company.

2.22 SUSPENSION AND ABATEMENT

In the event that Company’s operation from the Assigned Areas should be restricted substantially by action of the Federal government or agency thereof or by any judicial or legislative body, then Company will have the right, upon written notice to Aviation, to a suspension of this Agreement and an abatement of an equitable proportion of the payments to become due, from the time of such notice until such restrictions will have been remedied and normal operations restored.

2.23 RECOVERY OR RELOCATION OF ASSIGNED AREAS

- 2.23.1 Aviation may, in its unlimited discretion, at any time during the Term of this Agreement or any extensions, recover all or any part of the Assigned Areas for other Airport or public uses. Prior to the exercise of this power of recovery, Aviation agrees to give Company one hundred twenty (120) days prior written notice of its intention to exercise this power.

- 2.23.2 In the event the recovery is for a portion of the Assigned Areas, then this Agreement will continue except that the Assigned Areas will be modified. Such modification to the Assigned Areas will be reflected through the issuance of an Amendment and/or Space Use Letter, as provided for under Section 1.3.2 of this Agreement.
- 2.23.3 In the event of a total taking, Aviation will pay to Company a sum equal to the unamortized value of the fixed Improvements made to the Assigned Areas by Company. For the purposes of this Agreement and the determination of unamortized value, the parties agree that the said fixed Improvements will be amortized on a straight line method over the full term of this Agreement, excluding any option periods of this Agreement.
- 2.23.4 Aviation may, in its unlimited discretion, at any time during the term of this Agreement or any extensions thereof, relocate the Assigned Areas. Prior to the exercise of this power of relocation, Aviation agrees to give Company one hundred eighty (180) days prior written notice of its intention to exercise this power. In the event of such relocation, Aviation will pay to Company a sum equal to all of Company's reasonable expenses related to such relocation. Further, Aviation will use its best efforts to find a similar location suitable for Company's business operation and with similar exposure to the traveling public. Company will retain the right to terminate this Agreement with sixty (60) days prior written notice to Aviation if such replacement location is considered unsuitable, in Company's judgment.
- 2.23.5 In the event of any conflict between Section 2.23 and any other section in this Agreement, the entirety of Section 2.23 shall prevail.

2.24 ATTORNMENT

- 2.24.1 All subleases of Company will be subject to all terms and conditions of this Agreement. In the event Company ceases to be a party to this Agreement and perform its obligations hereunder to Aviation, other than by a transfer of interest and novation approved in writing by Aviation, all sublessees will recognize Aviation as the successor to Company, be bound by the terms and conditions of this Agreement and render performance hereunder to Aviation as if the Agreement were executed directly between Aviation and sublessees; provided, however, Aviation agrees that so long as sublessees are not in default, Aviation agrees to provide quiet enjoyment to sublessees and Aviation agrees to be bound by all of the terms and conditions of such sublease.
- 2.24.2 All subleases of Company will provide that if by reason of a default on the part of Company as lessee in the performance of the terms of the provisions of the underlying Agreement and the leasehold estate of Company as lessee thereunder is terminated by summary proceedings or otherwise in accordance with the terms of the underlying Agreement, all subleases will attorn to Aviation and recognize Aviation as lessor; provided, however, Aviation agrees that so long as such sublessees are not in

default, Aviation agrees to provide quiet enjoyment to the sublessee and to be bound by all of the terms and conditions of each sublease.

- 2.24.3 In the event this Agreement is terminated for any reason, all sublessees will be liable to Aviation for the payment of each pro rata share of the rentals and fees required under Section 1.5 of this Agreement. Payment of rentals, fees, and charges under this Section will entitle the sublessee to quiet enjoyment of the Assigned Areas pursuant to Section 4.2 of this Agreement.

ARTICLE III

3.1 MAINTENANCE AND OPERATION NON-DISCRIMINATION COMPLIANCE

Company, for itself, its heirs, personal representatives, successors in interest, and assigns, as a part of the consideration hereof, does hereby covenant and agree as a covenant running with the land that in the event facilities are constructed, maintained, or otherwise operated on the said property described in this Agreement for a purpose for which a U.S. Department of Transportation program or activity is extended or for another purpose involving the provision of similar services or benefits, Company will maintain and operate such facilities and services in compliance with all other requirements imposed pursuant to 49 CFR Part 21, Nondiscrimination in Federally Assisted Programs of the Department of Transportation and as said Regulation may be amended.

3.2 NON-DISCRIMINATION IN PARTICIPATION, CONSTRUCTION, AND USE OF ASSIGNED AREAS

3.2.1 Company, for itself, its personal representatives, successors in interest and assigns, and as a part of the consideration hereof, does hereby covenant and agree, as a covenant running with the land that:

- A. No person on the grounds of race, color, or national origin will be excluded from participation in, denied the benefits of, or be otherwise subjected to discrimination in the use of said facilities.
- B. In the construction of any improvements on, over, or under such land and the furnishing of services thereon, no person on the grounds of race, color or national origin will be excluded from participation in, denied the benefits of, or otherwise be subject to discrimination.
- C. Company will use the Assigned Areas in compliance with all other requirements imposed by or pursuant to 49 CFR Part 21, Nondiscrimination in Federally Assisted Programs of the Department of Transportation and as said Regulations may be amended.

3.3 TERMINATION RIGHTS FOR BREACH OF SECTIONS 3.1 AND 3.2

In the event of breach of any of the nondiscrimination covenants described in Sections 3.1 and 3.2 above, Aviation will have the right to terminate this Agreement and to reenter and repossess the Assigned Areas and the facilities thereon, and hold the same as if this Agreement had never been made or issued. This provision, however, does not become effective until the procedures of 49 CFR Part 21 are followed and completed, including expiration of appeal rights. Promptly upon the receipt of any complaint or other notice alleging violation of the covenants in Sections 3.1 and 3.2, Aviation will notify Company and will provide Company the opportunity to defend the same.

3.4 NON-DISCRIMINATION IN FURNISHING ACCOMMODATIONS AND/OR SERVICES

Company will furnish its accommodations and/or services on a fair, equal and not unjustly discriminatory basis to all users thereof and it will charge fair, reasonable and not unjustly discriminatory prices for each unit or service provided that Company may be allowed to make reasonable and nondiscriminatory discounts, rebates or other similar type of price reductions to volume purchasers.

3.5 RIGHTS FOR NONCOMPLIANCE WITH SECTION 3.4

Noncompliance with Section 3.4 above will constitute a material breach of this Agreement and in the event of such noncompliance, Aviation will have the right to terminate this Agreement and the estate hereby created without liability or at the election of Aviation or the United States of America either or both said Governments will have the right to judicially enforce the provision.

3.6 COMPANY'S OBLIGATION 49 CFR PART 23

3.6.1 This Agreement is subject to the requirements of the U.S. Department of Transportation's regulations, 49 CFR Part 23. Company agrees that it will not discriminate against any business owner because of the owner's race, color, national origin or sex in connection with the award or performance of any agreement covered by 49 CFR Part 23.

3.6.2 Company agrees to include the above statements in any subsequent sublease, professional services and/or construction agreements that it enters and cause those businesses to similarly include the statements in further agreements.

3.7 SUBAGREEMENT NON-DISCRIMINATION COMPLIANCE

Company hereby assures it will include Sections 3.1 through 3.24 clauses in all subleases and causes sublessees to similarly include clauses in further subleases.

3.8 COMPANY OBLIGATION

Company hereby assures that no person shall be excluded from participation in, denied the benefits of or otherwise be discriminated against, in connection with the award and performance of any contract, including leases, covered by 49 CFR Part 23 on the grounds of race, color, national origin or sex, or any other protected status.

3.9 GENERAL CIVIL RIGHTS PROVISION

The Company agrees to comply with pertinent statutes, Executive Orders and such rules as

are promulgated to ensure that no person shall, on the grounds of race, creed, color, national origin, sex, age, or disability be excluded from participating in any activity conducted with or benefiting from Federal assistance. If the Company transfers its obligations to another, the transferee is obligated in the same manner as the Company.

This provision obligates the Company for the period during which the property is owned, used or possessed by Company and the Airport remains obligated to the Federal Aviation Administration. This provision is in addition to that required by Title VI of the Civil Rights Act of 1964.

3.10 AFFIRMATIVE ACTION EMPLOYMENT PROGRAMS

- 3.10.1 Company assures that it will undertake an Affirmative Action Program as required by 14 CFR Part 152, Subpart E, to ensure that no person shall on the grounds of race, creed, color, national origin, sex, or any other protected status, be excluded from participating in any employment activities covered in 14 CFR Part 152, Subpart E. Company assures that no person will be excluded on these grounds from participating in or receiving the services or benefits of any program or activity covered by this subpart. Company assures that it will require that its covered sub-organizations provide assurances to Company that they similarly will undertake Affirmative Action Programs and that they will require assurances from their sub-organizations, as required by 14 CFR Part 152, Subpart E to the same effect.
- 3.10.2 Company agrees to comply with any affirmative action plan or steps for equal employment opportunity required by 14 CFR Part 152, Subpart E, as part of the affirmative action program, and by any Federal, State, or local agency or court, including those resulting from a conciliation agreement, a consent decree, court order or similar mechanism. Company agrees that State or local affirmative action plans will be used in lieu of any affirmative action plan or steps required by 14 CFR Part 152, Subpart E, only when they fully meet the standards set forth in 14 CFR, Subpart 152.409. Company agrees to obtain a similar assurance from its covered organizations, and to cause them to require a similar assurance of their covered sub-organizations, as required by 14 CFR Part 152, Subpart E.
- 3.10.3 In the event Company employs fifty (50) or more employees on the Airport, it agrees to prepare and keep on file for review by the FAA Office of Civil Rights, an affirmative action plan developed in accordance with standards in 14 CFR, Subpart 152.409. Such program will be updated on an annual basis. Should Company employ less than fifty (50) employees on the Airport, it will annually send written correspondence confirming the exemption.

3.11 AIRPORT MAINTENANCE, REPAIR, DEVELOPMENT, AND EXPANSION

Aviation reserves the right to further develop or improve the landing area or any other area, building or other improvement within the present or future boundaries of the Airport as it sees fit in its sole judgment, regardless of the desires or view of Company and without interference or hindrance by Company. Further, Aviation retains the absolute right to maintain, repair, develop and expand the terminal building, any other Airport facility, Airport improvement or Airport property free from any and all liability to Company for loss of business or damage of any nature whatsoever as may be occasioned during or because of the performance of such maintenance, repair, development or expansion.

3.12 MAINTENANCE, REPAIR, DIRECTION, AND CONTROL

Aviation reserves the right, but is not obligated to exercise the right, to maintain and keep in repair the landing area of the Airport and all publicly owned facilities of the Airport, together with the right to direct and control all activities of Company in this regard. These areas will include, but are not limited to, those areas which are necessary to serve the aeronautical users of the Airport, except that Aviation will not be obligated to maintain and keep in repair such areas of the Airport as may be leased to or under the control of Airport tenants whether such area serves aeronautical users or otherwise.

3.13 AGREEMENTS WITH THE UNITED STATES OF AMERICA

This Agreement will be subject and subordinate to the provisions and requirements of any existing or future agreement between Aviation and the United States of America relative to the development, operation or maintenance of the Airport.

3.14 OPERATION OF AIRPORT BY THE UNITED STATES OF AMERICA

This Agreement and all the provisions hereof will be subject to whatever right the United States of America now has or in the future may have or acquire, affecting the control, operation, regulation and taking over of said Airport or the exclusive or nonexclusive use of the Airport by the United States during the time of war or national emergency.

3.15 PART 77 OF FEDERAL AVIATION REGULATIONS

Company agrees to comply with the notification and review requirements covered in Part 77 of the Federal Aviation Regulations in the event future construction of a building is planned for the leased Assigned Areas, or in the event of any planned modification or alteration of any present or future building or structure situated on the leased Assigned Areas.

3.16 NONEXCLUSIVE

It is understood and agreed that nothing herein contained will be construed to grant or authorize the granting of an exclusive right within the meaning of Section 308 of the Federal

Aviation Act of 1958, (49 U.S.C. 1349a).

3.17 AIRSPACE

There is hereby reserved to Aviation, its successors and assigns, for the use and benefit of the public, a right of flight for the passage of aircraft in the airspace above the surface of the Assigned Areas herein leased. This public right of flight will include the right to cause or allow in said airspace, any noise inherent in the operation of any aircraft used for navigation or flight through the said airspace or landing at, taking off from or operation on the Airport. No liability on the part of Aviation will result from the exercise of this right.

3.18 AIRPORT OBSTRUCTIONS

Company, by accepting this Agreement, expressly agrees for itself, its successors and assigns, that it will not erect nor permit the erection of any structure or object, nor permit the growth of any tree on the land leased hereunder which will exceed such maximum height as may be stipulated by Aviation. It is understood and agreed that applicable laws, codes, regulations or agreements concerning height restrictions will govern the maximum height to be stipulated by Aviation. In the event the aforesaid covenants are breached, Aviation reserves the right to enter upon the land leased hereunder and to remove the offending structure or object and cut down the offending tree, all of which will be at the expense of Company and without liability to Aviation.

3.19 AIRPORT HAZARDS

Company, by accepting this Agreement, agrees for itself, its successors and assigns, that it will not make use of the Assigned Areas in any manner which might interfere with the landing and taking off of aircraft from Airport or otherwise constitute a hazard or obstruction. In the event the aforesaid covenant is breached, Aviation reserves the right to enter upon the Assigned Areas and cause the abatement of such interference at the expense of Company and without liability of any kind.

3.20 AIRPORT RULES AND REGULATIONS AND OPERATING DIRECTIVES

3.20.1 Company hereby agrees to be bound in the operation of its service at the Airport by all Airport Rules and Regulations, Airport Tenant Improvement Manual, Operating Directives, Department of Aviation Environmental Management System, Airport Security Program, Nevada Revised Statutes, County Ordinances or other such governmental regulations, whether municipal, state, or federal, including, but not limited to, all Environmental Laws, and will immediately, upon request, verify compliance to any such requirement. Company must adhere to the Airport Rules and Regulations and Operating Directives, as may be amended from time to time. Company agrees to be subject to any fines and/or administrative assessment or penalties resulting from violations of any Rules and Regulations and Operating Directives. Company will keep current municipal, state, or federal licenses or

permits required for the conduct of its business, if any.

3.20.2 Company shall be responsible for and shall pay to Aviation any penalties and/or administrative assessments, as established by the Operating Directives, and imposed by the Director for any violation of the Airport Rules and Regulations, Operating Directives, and/or terms and conditions of this Agreement. Such payments shall be due within thirty (30) days after the receipt of such notice of violations.

3.20.3 Aviation, through the Director, will have the right to adopt, amend and enforce reasonable rules and regulations and operating directives with respect to use of and the conduct and operation of the Airport, its terminal buildings, or any improvements within the present or future boundaries of the Airport which Company agrees to observe and obey.

3.21 COMPLIANCE WITH PUBLIC AUTHORITIES

3.21.1 Company will not use or permit the use of the demised Assigned Areas or any other portion of the Airport for any purpose or use other than authorized by this Agreement or as may be authorized by other, separate, written agreement with Aviation.

3.21.2 Company, its employees, representatives or agents will comply with all present or future laws, rules and regulations and amendments or supplements thereto governing or related to the use of the Airport or the demised Assigned Areas as may from time to time be promulgated by federal, state, or local governments and their authorized agencies.

3.22 AMERICANS WITH DISABILITIES ACT

Company will throughout the Term of this Agreement be in compliance with all applicable provisions of the Americans With Disabilities Act of 1990, as amended from time to time, as well as any other applicable rules, regulations, laws, ordinances, either in effect now, or as may be promulgated. Company will ultimately be responsible for all aspects of safety and security related to its operations. Company shall be responsible to provide and maintain all necessary equipment needed to meet the requirements of this Section. All such equipment must be submitted to Aviation for approval prior to implementation. Such equipment or devices shall also comply with Sections 1.10 and 1.11 of this Agreement. Company shall not make any modifications to Aviation's facilities, including the installation of equipment that may be required to comply with this Section, without prior written approval from the Director. Company will be required to provide appropriately trained staff to meet the requirements of this Section.

3.23 ENVIRONMENTAL POLICY

3.23.1 **Environmental Compliance:** Company agrees to be bound in the operation of its service at the Airport by the Department of Aviation Environmental Management

System, Nevada Revised Statutes, County Ordinances or other such governmental regulations, whether municipal, state, or federal, including, but not limited to, those that deal with Hazardous Material and/or the regulation of protection of the environment, including ambient air, ground water, surface water, and land use, including sub strata land. Company will immediately, upon request, verify compliance to any such requirement, which may be amended or otherwise modified from time to time.

3.23.2 Violation of Environmental Laws: Company will not cause or permit any Hazardous Material to be used, generated, manufactured, produced, stored, brought upon, or Released on, under or about the Airport, or transported to and from the Airport, by Company, its sublessees, their agents, employees, contractors, invitees or a third party in violation of the Environmental Laws as defined in this Agreement, or the Department of Aviation Environmental Management System, as it now exists, or as may be modified from time to time; provided, however, medical waste and other materials used as part of Company's business operations conducted in strict accordance with all Environmental Laws, prudent industry practice and the standards of this Agreement shall not be considered Hazardous Material.

- A. Aviation will inspect areas to insure that Company is using the Airport in accordance with environmental requirements.
- B. Upon request of Aviation, Company will conduct such testing and analysis as necessary to ascertain whether Company is using the Airport in compliance with environmental requirements. Any such tests will be conducted by qualified independent experts chosen by Company and subject to Director's reasonable approval. Copies of such reports from any such testing will be provided to the Director.
- C. Company will provide copies of all notices, reports, claims, demands or actions concerning any environmental concern or release or threatened Release of Hazardous Materials or special wastes to the environment.
- D. To Aviation's knowledge, Aviation has not received written notice from a governmental agency within the thirty (30) day period preceding the BOD informing Aviation of the existence of Hazardous Material in or at the Assigned Areas which Aviation is required to remove pursuant to applicable laws.

3.23.3 Contamination of Assigned Areas: If the presence of any Hazardous Materials on, under or about any area of the Airport caused or permitted by Company results in any contamination of the Airport, Company will promptly take all actions, at its sole cost and expense, as are necessary to return the contaminated area to the condition existing prior to the introduction of any such Hazardous Material. Company will take all steps necessary to remedy and remove any such hazardous materials and

special wastes and any other environmental contamination as is necessary to protect the public health and safety and the environment from actual or potential harm and to bring the contaminated area into compliance with all environmental requirements such procedures are subject to:

- A. Prior approval of the Director, which approval will not be unreasonably withheld, Company will submit to the Director a written plan for completing all remediation work. The Director retains the right to review and inspect all such work at any time using consultants and/or representatives of the Director's choice.
- B. Such actions of remediation by Company will not potentially have any material adverse long-term effect on the Assigned Areas in the sole judgment of the Director.

3.23.4 Compliance with All Governmental Authorities: Company will promptly make all submission to, provide all information to, and comply with all requirements of the appropriate governmental authority under all Environmental Laws, or the Department of Aviation Environmental Management System, as it now exists or as may be modified from time to time. Company shall promptly provide photocopies to Director of any submissions to and/or from environmental regulating agencies.

- A. Should the government determine that a site characterization, site assessment, and/or cleanup plan be prepared or that a cleanup should be undertaken because of any spills or discharges of Hazardous Materials at the Airport which occur during the Term of this Agreement then Company shall (at its own expense) prepare and submit required plans and financial assurances, and carry out the approved plans. Company will, at no cost or expense to Aviation, promptly provide all information requested by the Director to determine the applicability of the Environmental Laws to the Airport, or to respond to any governmental investigation or to respond to any claim of liability by third parties which is related to environmental contamination.
- B. Company's obligations and liabilities under this provision will continue so long as Aviation bears any responsibility under the Environmental Laws for any action that occurred on the Airport as a result of Company's actions.
- C. Pursuant to this Section 3.23.4, Company shall be responsible for all costs incurred in connection with any investigation of site conditions or any cleanup, remedial, removal, restoration, any fines or penalties issued to Company or Aviation, or any other work required by any federal, state or local governmental agency or political subdivision because of Hazardous Material located on the Airport or present in the soil or ground water on, under or about the Airport caused or permitted by Company.

3.23.5 Aviation's Termination Rights for Violation of Environmental Laws:

Company's failure or its sublessees, their agents, employees, contractors, invitees or the failure of a third party to comply with any of the requirements and obligations of this Agreement or applicable Environmental Laws will constitute a material default of this Agreement and will permit Aviation to pursue the following remedies, in addition to all other rights and remedies provided by law or otherwise provided in this Agreement, to which Aviation may resort cumulatively, or singularly, in the alternative.

- A. Aviation may, at Aviation's election, keep this Agreement in effect and enforce all of its rights and remedies under this Agreement, including (i) the right to recover rent and other sums as they become due by the appropriate legal action and/or (ii) the right, upon ten (10) days' written notice to Company, to make payments required of Company or perform Company's obligations and be reimbursed by Company for the cost, unless such payment is made or obligation performed by Company within such ten (10) day period.
- B. Aviation may, at Aviation's election, terminate this Agreement upon written notice to Company as provided in Section 2.19 of this Agreement. Except as otherwise specifically set forth herein, if this Agreement is terminated under this provision, Company waives all rights against Aviation, including, but not limited to, breach of contract, costs of design, installation or construction of Improvements and/or interruption of business.
- C. Notwithstanding any other provision in this Agreement to the contrary, Aviation will have the right of "self-help" or similar remedy, including access to the Assigned Areas, in order to minimize any damages, expenses, penalties and related fees or costs, arising from or related to a violation of environmental law on, under or about the Airport.

3.23.6 The provisions of this Section 3.23, shall survive the expiration or earlier termination of this Agreement.

3.24 AIRPORT SECURITY PLANS - FAR PART 107 AND CARD ACCESS SYSTEM

All personnel requiring access to the Airport Terminal Building or Airport Operations Area will be required to obtain identification and clearance, which shall be issued at the sole discretion of Director and in accordance with Airport Rules and Regulations Code and the Airport Master Security Plan. Company covenants that it will at all times maintain the integrity of the Airport Master Security Plan - FAR Part 107 and the Automated Access Control System. Company hereby agrees that it shall also be responsible for conducting and verifying any and all required background checks and for badging for any and all of its employees, subcontractors, suppliers, agents, and/or representatives. Company also hereby agrees that it shall also be responsible for any and all of the actions of its employees, subcontractors, suppliers, agents, and/or representatives and shall provide any and all

necessary escorts, as outlined in the Airport's Security Program, at all times. Company covenants that it will always maintain the security of any airfield access, which Company maintains. Should Company allow unauthorized access to the Airport Operations or Security Area, and should County be cited for a civil penalty, Company agrees to reimburse County for any monetary civil penalty, which may be imposed by an appropriate agency. Company may also have badge/access privileges immediately suspended and/or revoked by the Airport Security Administrator for failure to adhere to the Airport's Security Program or for failure to return all badges within the specified time frames.

- 3.25** To the best of Aviation's knowledge, neither Aviation nor any of its affiliates (a) are excluded from participation in any federal health care program, as defined under 42 U.S.C. §1320a-7b (f), for the provision of goods or services for which payment may be made under such federal health care programs and (b) has arranged or contracted (by employment or otherwise) with any employee, contractor or agent that such party or its affiliates know or should know are excluded from participation in any federal health care program, to provide goods or services hereunder. To the best of Aviation's knowledge, no final adverse action, as such term is defined under 42 U.S.C. §1320a-7e (g), has occurred or is pending or threatened against Aviation or its affiliates or to their knowledge against any employee, contractor or agent engaged by Aviation.

ARTICLE IV

4.1 FORCE MAJEURE

Neither Aviation nor Company will be deemed to be in breach of this Agreement by reason of failure to perform any of its obligations hereunder if, while and to the extent that such failure is due to strikes, boycotts, labor disputes, embargoes, shortages of materials, acts of God, acts of the public enemy, acts of governmental authority, unusual weather conditions, floods, riots, rebellion or sabotage. However, the provisions of this Section will not apply to failure by Company to pay rents, fees or any other money payments required under other provisions, covenants or agreements contained in this Agreement.

4.2 QUIET ENJOYMENT

Aviation agrees that, on payment of the rentals and fees and performance of the covenants, conditions and agreements on the part of Company to be performed hereunder, Company will have the right to peaceably occupy and enjoy the Assigned Areas.

4.3 NONLIABILITY OF INDIVIDUALS

No officer, agent or employee of either party to this Agreement will be charged personally or held contractually liable by or to the other party under any term or provision of this Agreement or because of any breach thereof, or because of its execution or attempted execution of this Agreement.

4.4 HEADINGS, TITLES, OR CAPTIONS

Article, section or paragraph headings, titles or captions are inserted only as a matter of convenience and for reference, and in no way define, limit or describe the scope or extent of any provision of this Agreement.

4.5 INVALID PROVISIONS

It is expressly understood and agreed by and between the parties hereto that in the event any covenant, condition or provision herein contained is held to be invalid by any court of competent jurisdiction, the invalidity of such covenant, condition or provision will in no way affect any other covenant, condition or provision herein contained; provided, however, that the invalidity of any such covenant, condition or provision does not materially prejudice either Aviation or Company in its respective rights and obligations contained in the valid covenants, conditions or provisions of this Agreement.

4.6 NON-DISCRIMINATION

Company agrees to comply with all federal, state and local laws regarding non-discrimination.

- 4.6.1 Aviation is committed to promoting full and equal protection and opportunity for all persons doing business with Clark County. Company, acknowledges that Aviation has an obligation to ensure Company, or Company's Agents, do not engage in any discriminatory practices at any time during the term of this Agreement. Company further acknowledges that if Company, or Company's Agents, are found guilty by an appropriate authority for refusing to grant services in places of public accommodations or to do business with an individual or company due to reasons of race, color, religion, sex, sexual orientation, gender identity or gender expression, age, disability, national origin, ancestry, or any other protected status, as provided by law, Aviation may elect to terminate this Agreement.
- 4.6.2 In connection with the performance of work under this Agreement, the Company, and Company's Agents, agree not to discriminate against any employee or applicant for employment because of race, color, religion, sex, sexual orientation, gender identity or gender expression, age, disability, national origin, ancestry, or any other protected status, as provided by law, including, without limitation, with regard to employment, upgrading, demotion or transfer, recruitment or recruitment advertising, layoff or termination, rates of pay or other forms of compensation, and selection for training, including, without limitation, apprenticeship.
- 4.6.3 As used in this Section, "sexual orientation" means having or being perceived as having an orientation for heterosexuality, homosexuality, or bisexuality.
- 4.6.4 As used in this Section, "gender identity or expression" means a gender related identity, expression or behavior of a person, regardless of the person's assigned sex at birth.

Company further agrees to insert this provision in all subcontracts hereunder, except subcontracts for standard commercial supplies or raw materials.

4.7 INDEPENDENT CONTRACT

Company is deemed to be an independent contractor for all purposes regarding its operations at the Airport and no agency, expressed or implied, exists.

4.8 FULL AUTHORITY

In the event that the Federal Aviation Administration or its successors required modifications or changes in this Agreement as a condition precedent to the granting of funds for the improvement of the Airport, or otherwise, Company agrees to consent to such amendments, modifications, revisions, supplements, or deletions of any of the terms, conditions, or requirements of this Agreement as may be reasonably required. Any expenses resulting from such amendments, modifications, revisions, supplements or deletions, shall be born solely by Company.

4.9 ADVERSE TENANCY

Any unauthorized holding over by Company after the termination of this Agreement or the expiration of its terms without the written consent of Aviation, except for the period authorized for removal of Company's property upon the expiration or termination hereof, shall entitle Aviation to collect from Company as liquidated damages for such holding over, double the total of all rents and fees in effect immediately prior to the commencing of such holding over. The DOA may perfect a lien on the property of Company as security for the payment of any damages or unpaid commissions and shall be entitled to collect the same by foreclosure of such lien and sale of such property.

4.10 DISPUTES

Any and all disputes arising under this Agreement, which cannot be administratively resolved, shall be determined according to the laws of the State of Nevada, and Company agrees that the venue of any such dispute, either administratively or judicial, shall be in Clark County, Nevada. Company agrees as a condition of this Agreement that notwithstanding the existence of any dispute between the parties, insofar as is possible under the terms of this Agreement, each party shall continue to perform the obligations required of it during the continuation of any such dispute, unless enjoined or prohibited by a court of competent jurisdiction.

4.11 AGENT FOR SERVICE OF PROCESS

The parties hereto expressly understand and agree that if Company is not a resident of the State of Nevada, or is an association or partnership without a member or partner resident of said State, or is a foreign corporation, and then in any such event Company does designate its State of Nevada registered agent as its agent for the purpose of service of process in any court action between it and Aviation arising out of or based upon this Agreement, and the service shall be made as provided by the laws of the State of Nevada by serving also Company's registered agent. The parties hereto expressly agree, covenant, and stipulate that Company shall also personally be served with such process out of this State by the registered mailing of such complaint and process to Company at the address set forth herein. Any such service out of this State shall constitute valid service upon Company as of the date of receipt thereof. The parties hereto further expressly agree that Company is amenable to and hereby agrees to the process so served, submits to the jurisdiction, waives any and all obligations and protests thereto, any laws to the contrary notwithstanding.

4.12 GENDER

Words of any gender used in this Agreement shall be held and construed to include any other gender, and words in the singular number shall be held to include the plural, unless the context otherwise requires.

4.13 ENTIRE AGREEMENT

4.13.1 This document represents the entire Agreement between the parties hereto and will not be modified or canceled by mutual agreement or in any manner except by instrument in writing, executed by the parties or its respective successors in interest. The parties further understand and agree that the other party and its agents have made no representations or promises with respect to this Agreement or the making or entry into this Agreement, except as in this Agreement expressly set forth, and that no claim or liability for cause for termination shall be asserted by either party against the other, and such party shall not be liable by reason of, the making of any representations or promises not expressly stated in this Agreement, any other written or oral agreement with the other party being expressly waived.

4.13.2 The individuals executing this Agreement personally warrant that they have full authority to execute this Agreement on behalf of the entity for whom they are acting herein.

4.13.3 The parties hereto acknowledge that it has thoroughly read this Agreement, including any exhibits or attachments hereto, and have sought and received whatever competent advice and counsel was necessary for it to form a full and complete understanding of all rights and obligations herein.

4.14 SUCCESSORS AND ASSIGNS

This Agreement shall be binding upon and shall inure to the benefit of the parties hereto and its respective heirs, personal representatives, successors, or assigns, as the case may be. All covenants and conditions of this Agreement will extend to and bind the legal representatives, successors, and assigns of the respective parties thereto and all agreements with assignees or sublessees will include all provisions contained in this Agreement.

4.15 STATE OF NEVADA LAW

This Agreement will be interpreted under and governed by the Law of the State of Nevada.

4.16 ADDITIONAL CLAUSES

Company hereby acknowledges and agrees that it will be subject to the additional clauses contained in Exhibit "B" attached hereto and by reference made a part hereof.

4.17 COUNTERPARTS

This Agreement may be executed in a number of counterparts, each of which when so executed shall constitute the aggregate but one and the same document.

4.18 SURVIVABILITY

The terms and conditions of the Agreement regarding confidentiality, environmental compliance, indemnification, warranties, payments, dispute resolution and all others that by their sense and context are intended to survive the expiration of the Agreement will survive.

4.19 DIRECTOR'S AUTHORITY

The Director of Aviation has the authority to act on behalf of the Board of County Commissioners for all purposes under this Agreement, including the ability to terminate this Agreement as set forth herein.

IN WITNESS WHEREOF, Aviation and Company have executed these presents the day and year first above written.

CLARK COUNTY, NEVADA

UNIVERSITY MEDICAL CENTER OF SOUTHERN NEVADA

BY: _____
ROSEMARY A. VASSILIADIS
Director of Aviation

BY: _____
MASON VAN HOUWELING
Chief Executive Officer

APPROVED AS TO FORM:
Deputy District Attorney

BY:  _____
TIMOTHY BALDWIN

EXHIBIT "A"

1. ASSIGNED AREAS - EXHIBIT "A"

EXHIBIT A

KEY PLAN

SPACE ID(s):

T1-TBC-L2-180,181,182,183,184,185,186,187,188

ASSIGNED SPACE(s):



AREA:

1440.11 S.F.

Square footage calculations are based on McCarran International Airport standards.
Measurements are based on center wall delineations.

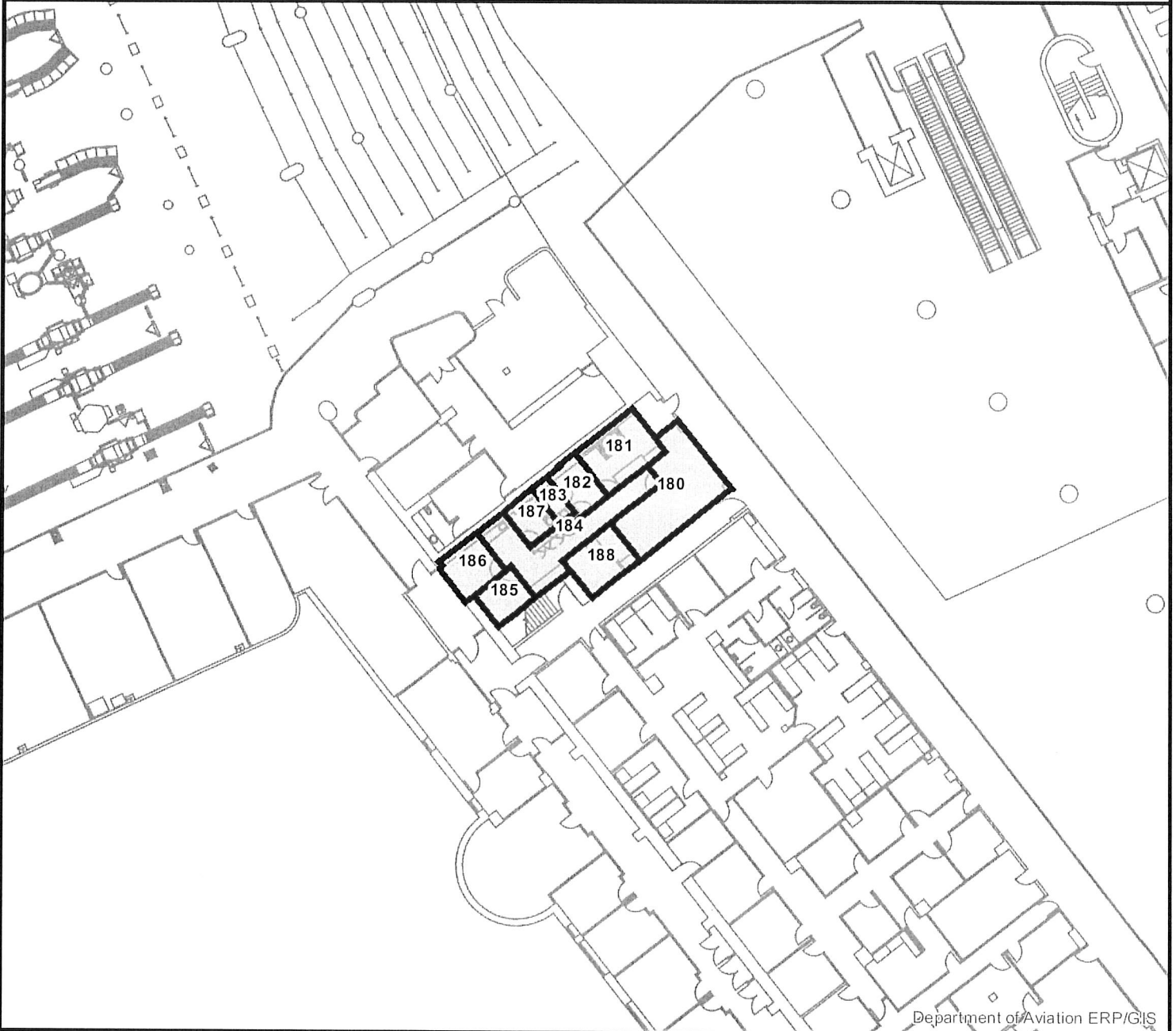
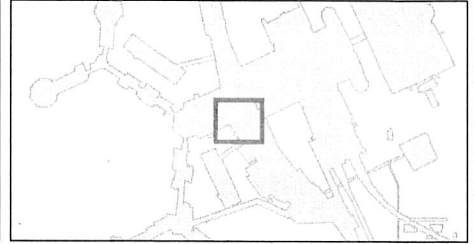

Department of Aviation ERP/GIS



McCarran
INTERNATIONAL AIRPORT

HND
HENDERSON EXECUTIVE AIRPORT

VGT
NORTH LAS VEGAS AIRPORT



UNIVERSITY MEDICAL CENTER OF SOUTHERN NEVADA
UMC
CONCESSION PASSENGER SERVICE SPACE
TERMINAL 1, TICKETING BUILDING CENTER, LEVEL 2

Scale
0 10 20 30
Feet

Date: 2/18/2021

Drawing Number

L21-0097

TERMINAL 1 BAGGAGE CLAIM SOUTH + NORTH

EXHIBIT "A"

Hand Sanitizer Units

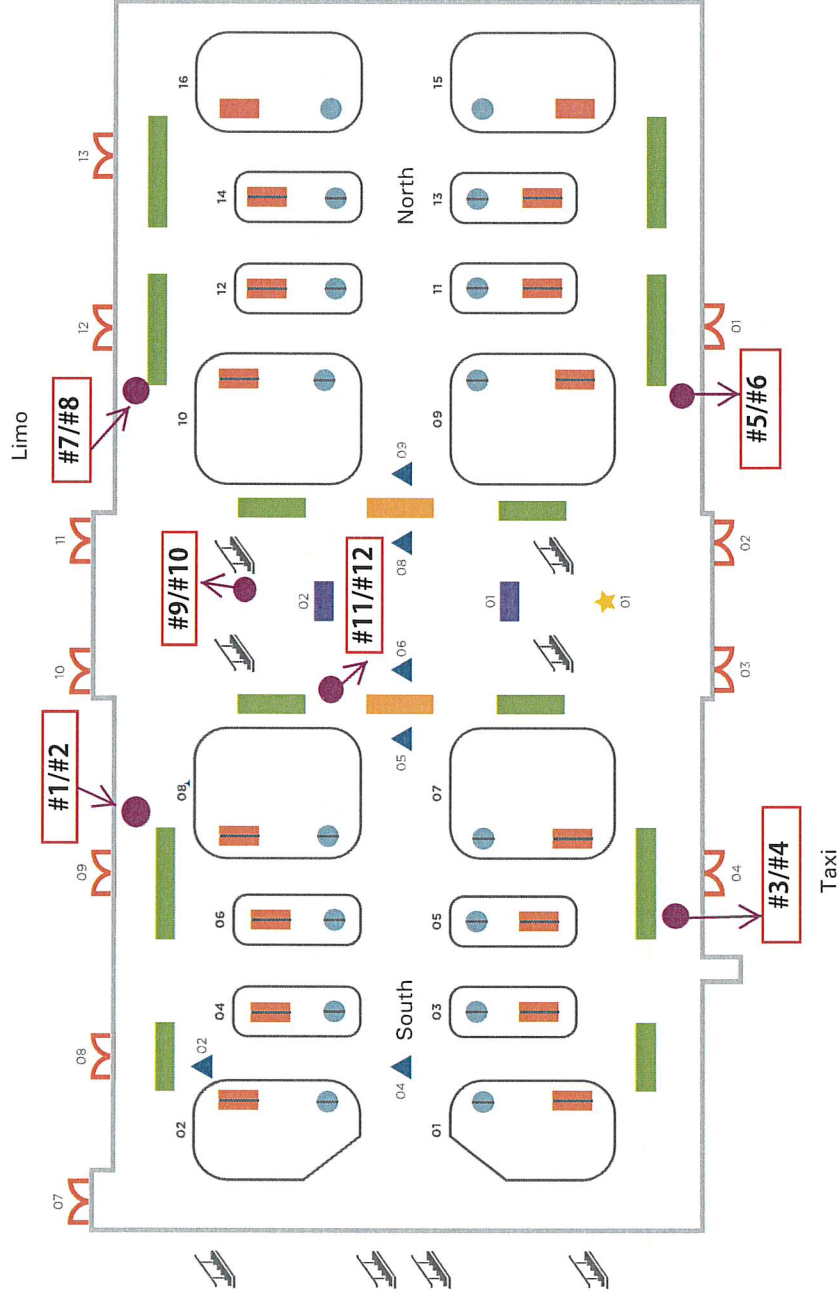
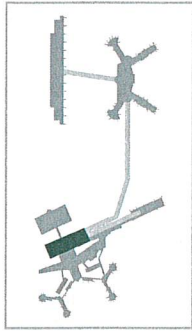

- Custom Spectacular Wall Signs
- 3 Sided Rotators
- Floor Display
- Spectacular Digital Network (SDN)
- Banner Digital Network (BDN)
- Baggage Carousel Digital Network (BCDN)
- Audio Video Digital Network (AVDN)
- Exit Sponsorship
- Escalator

TERMINAL 1 BAGGAGE CLAIM - SECOND LEVEL

EXHIBIT "A"

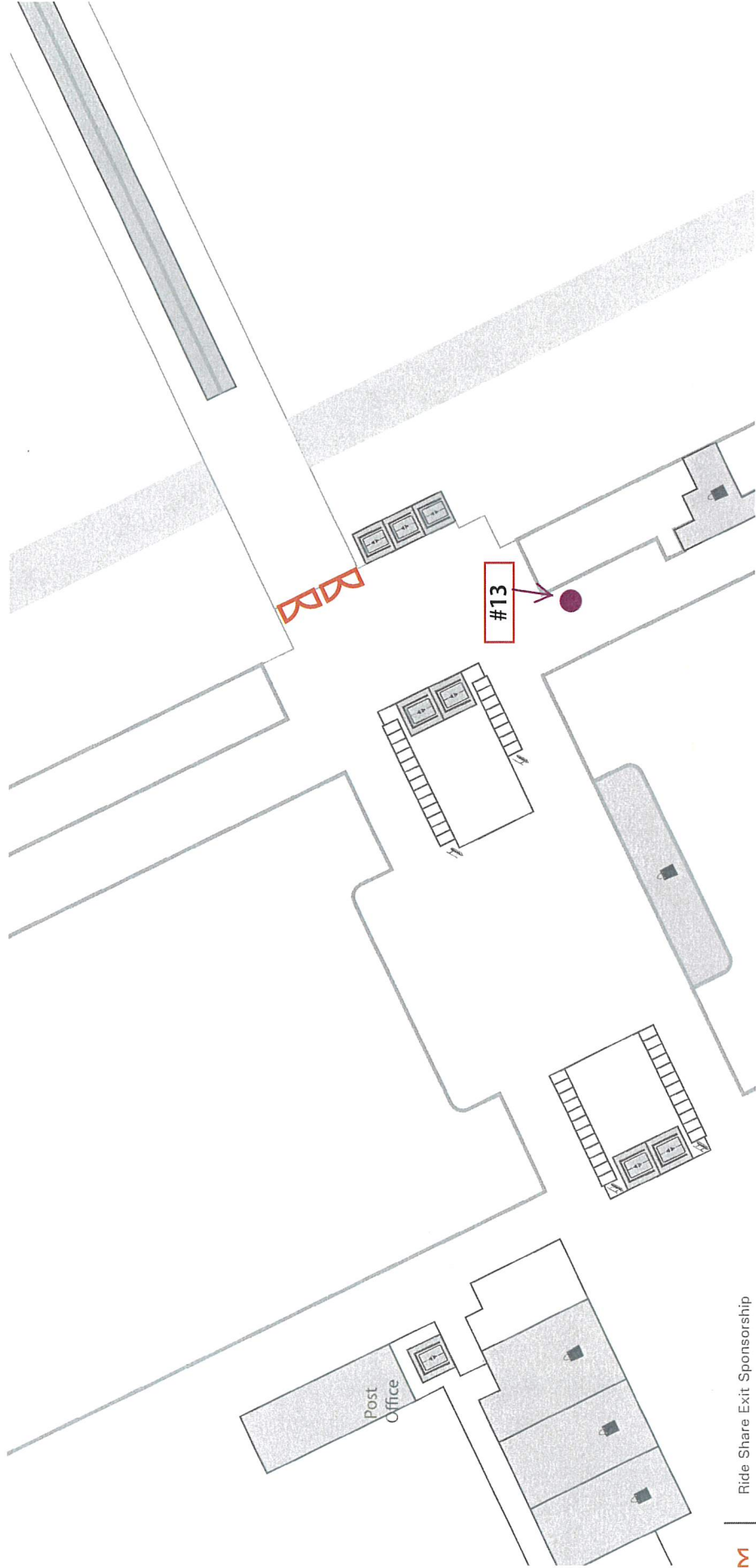
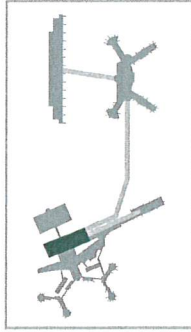

Ride Share Exit Sponsorship

Escalator



RENTAL CAR FACILITY

EXHIBIT "A"

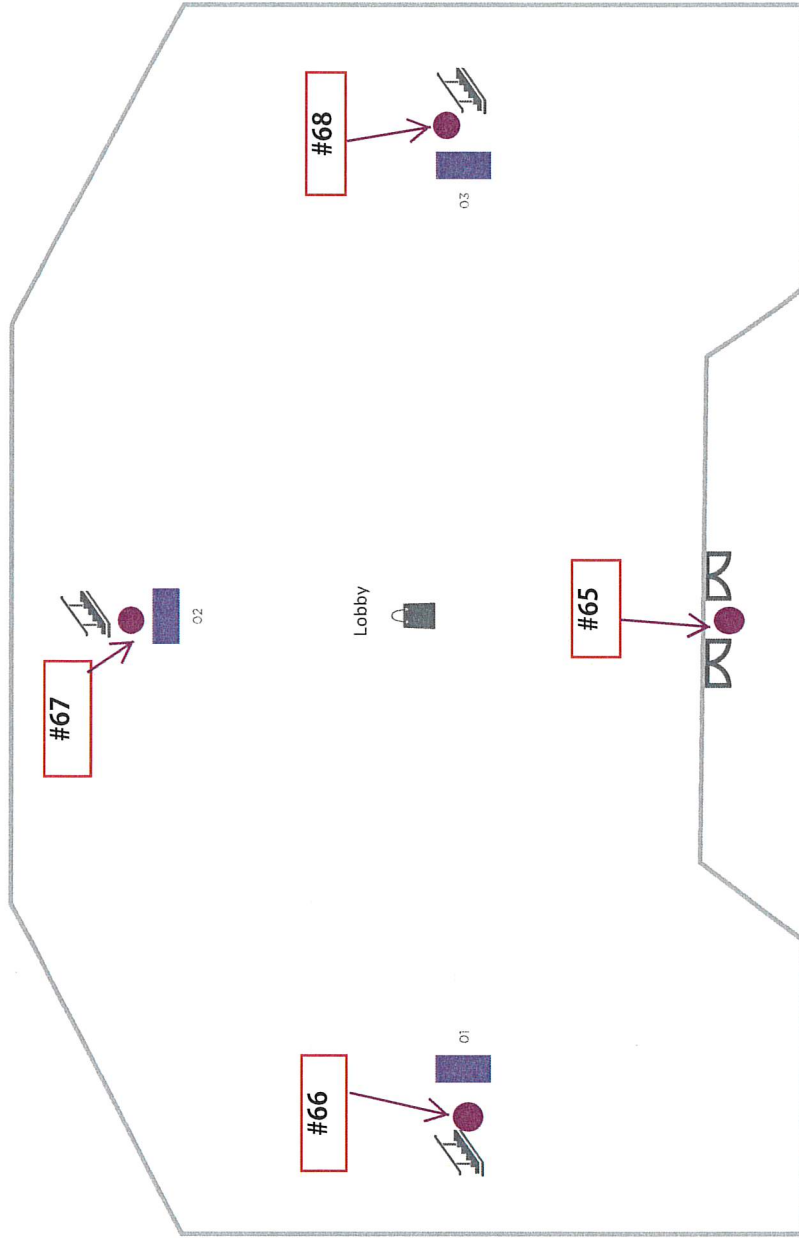
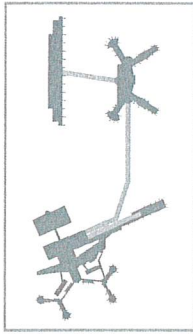





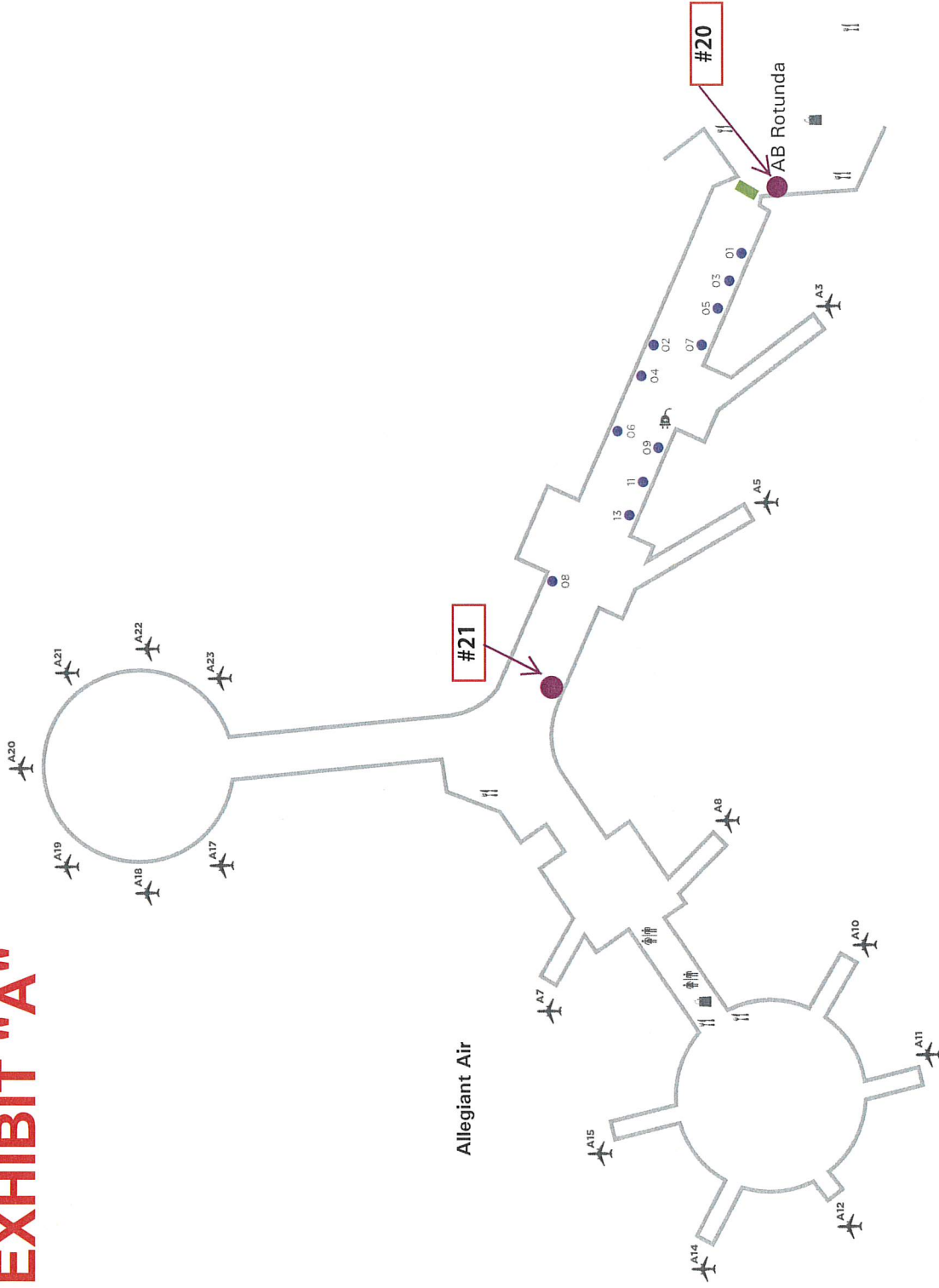
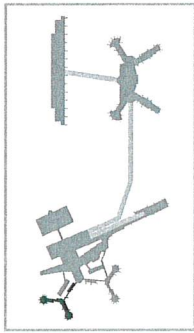

- Custom Spectacular
- Escalator
- Shopping
- Entrance And Exit

TERMINAL 1 CONCOURSE A

EXHIBIT "A"



-  Extra Large Wall Diorama
-  Concourse Digital Network (CDN)
-  Recharge Zone
-  Bathroom
-  Food And Beverage
-  Shopping

TERMINAL 1 CONCOURSE B

EXHIBIT "A"

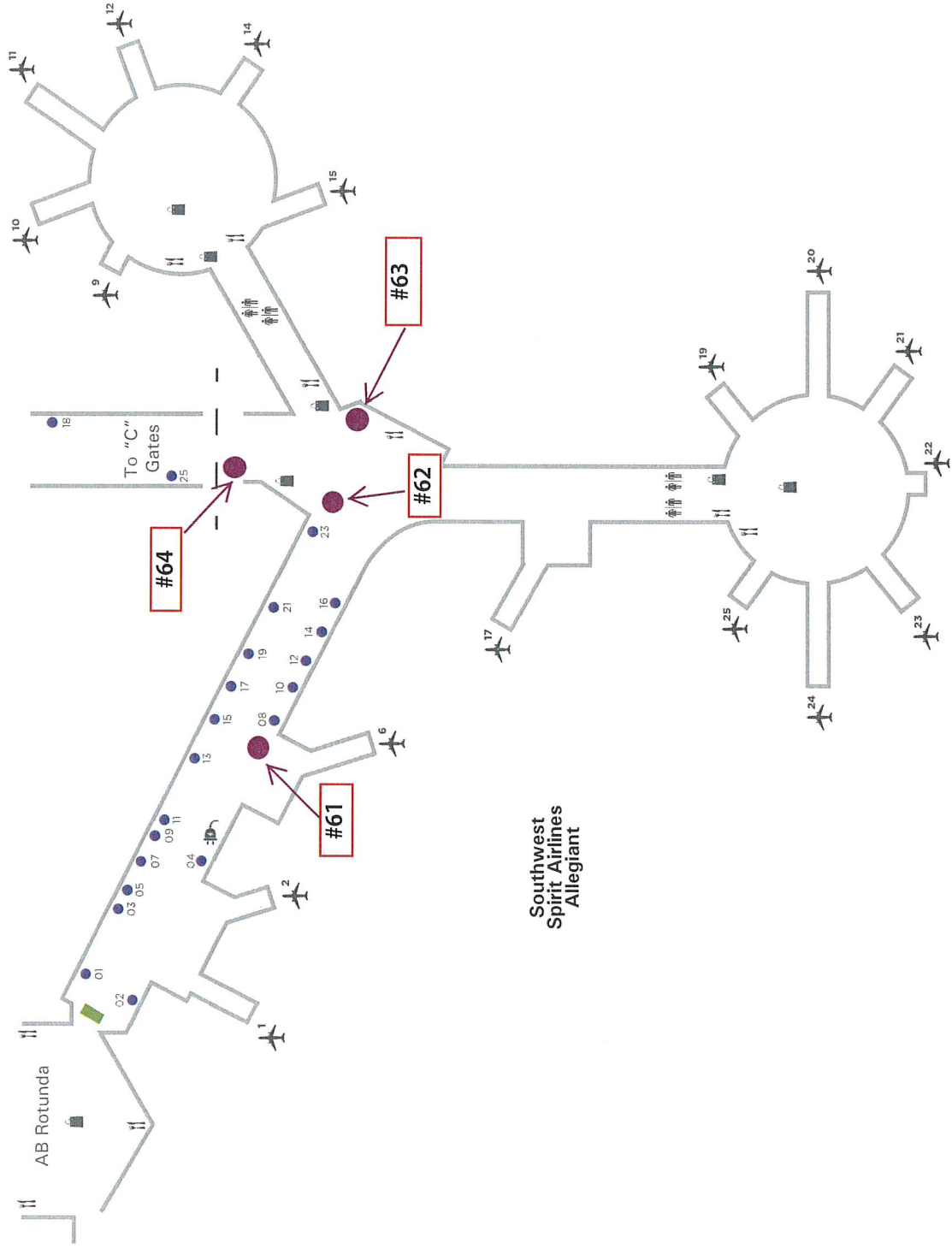
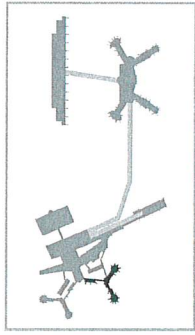

- Extra Large Wall Diorama
- Concourse Digital Network (CDN)
- ☺ Recharge Zone
- 🚻 Bathroom
- 🍴 Food And Beverage
- 🛍 Shopping

TERMINAL 1 CONCOURSE C

EXHIBIT "A"

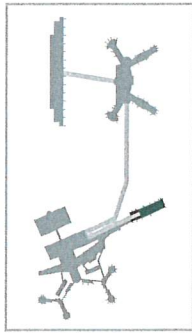

To/From "D" Gates

Southwest

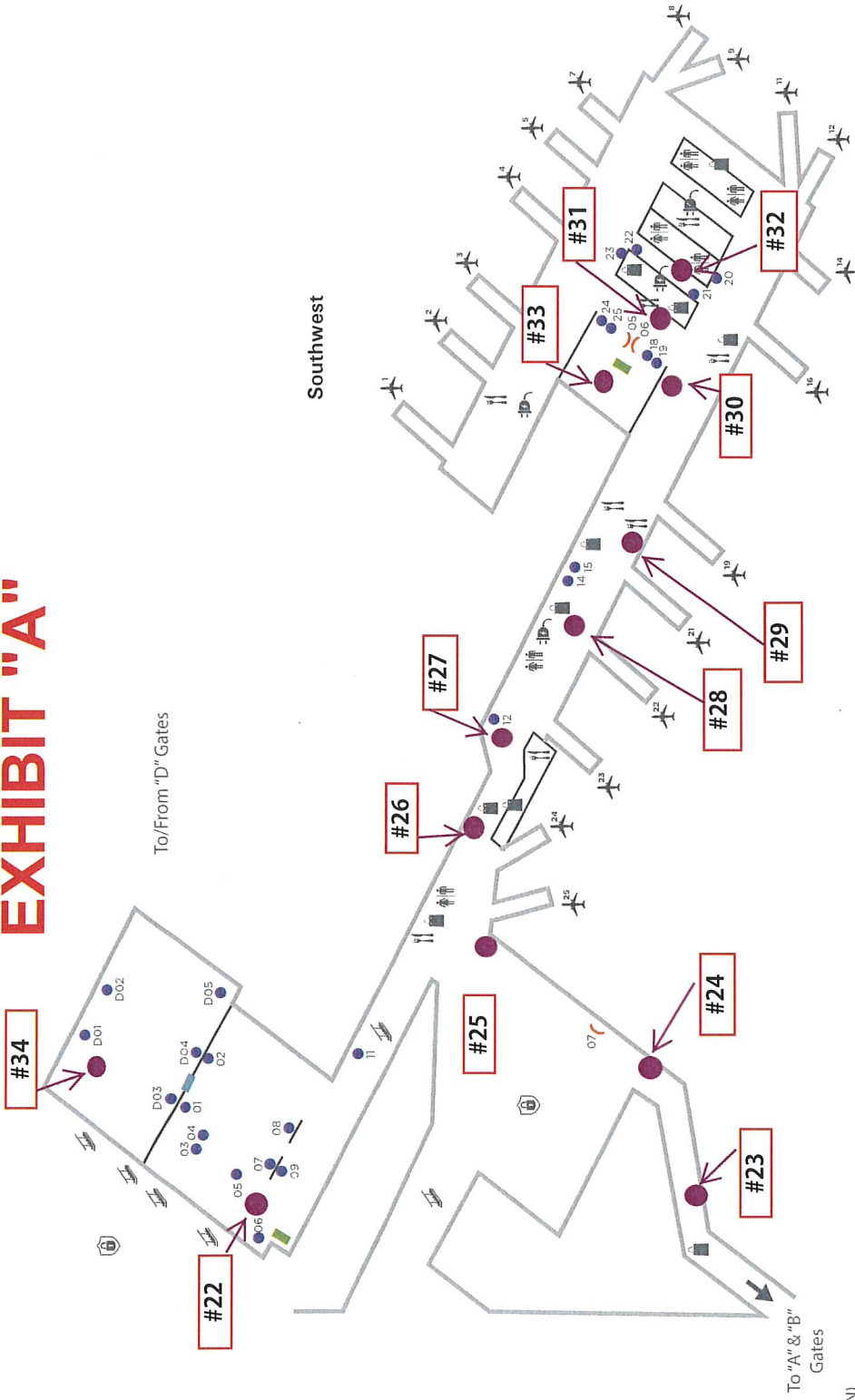

- CD Tram Window Wrap
- Wall Wrap
- Extra Large Wall Diorama
- Concourse Digital Network (CDN)
- Escalator
- Recharge Zone
- Food And Beverage
- Shopping
- Bathroom
- TSA / Security

TERMINAL 1 CONCOURSE

EXHIBIT "A"

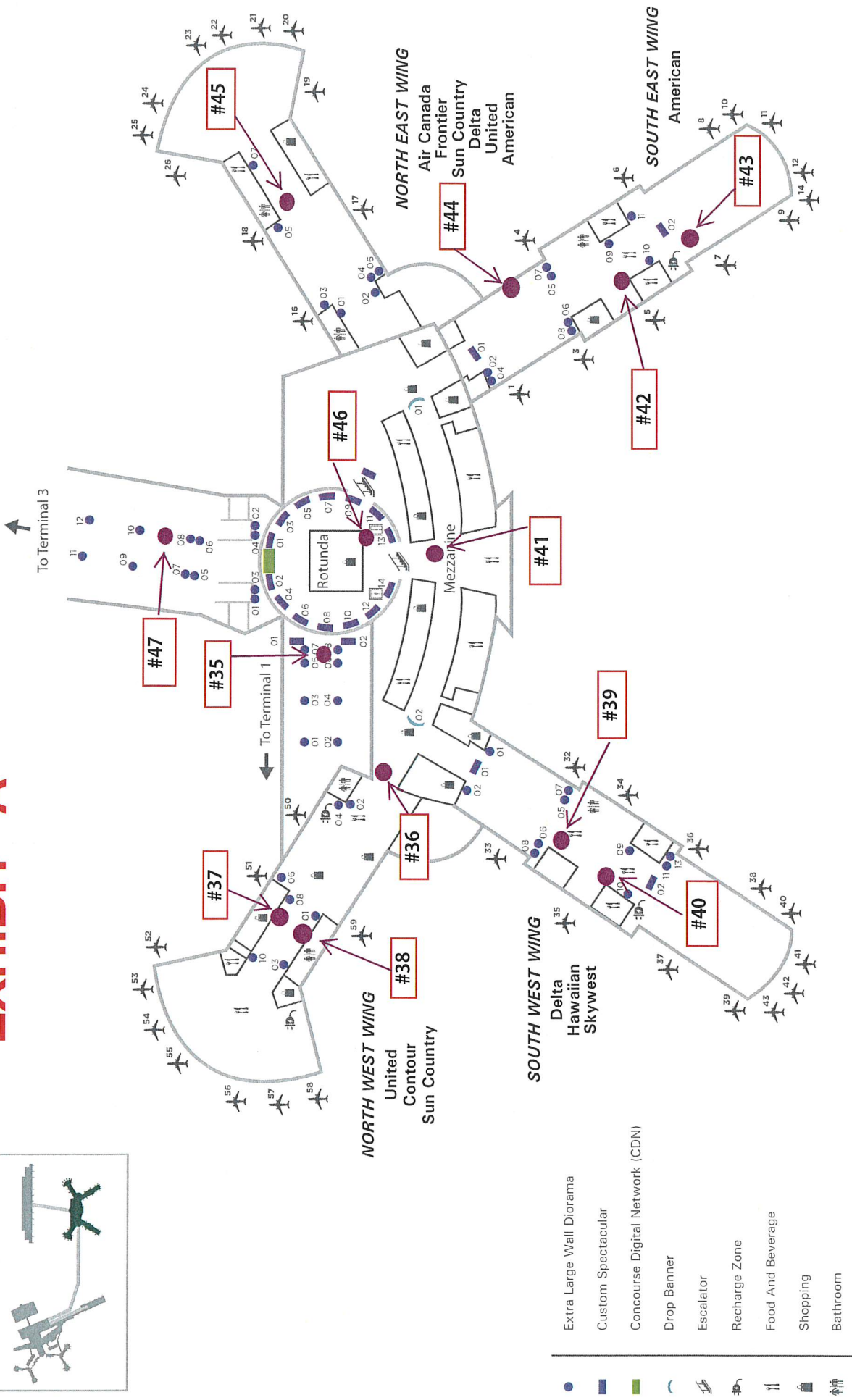
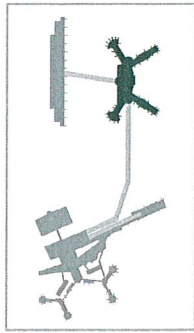

TERMINAL 1 ESPLANADE

EXHIBIT "A"

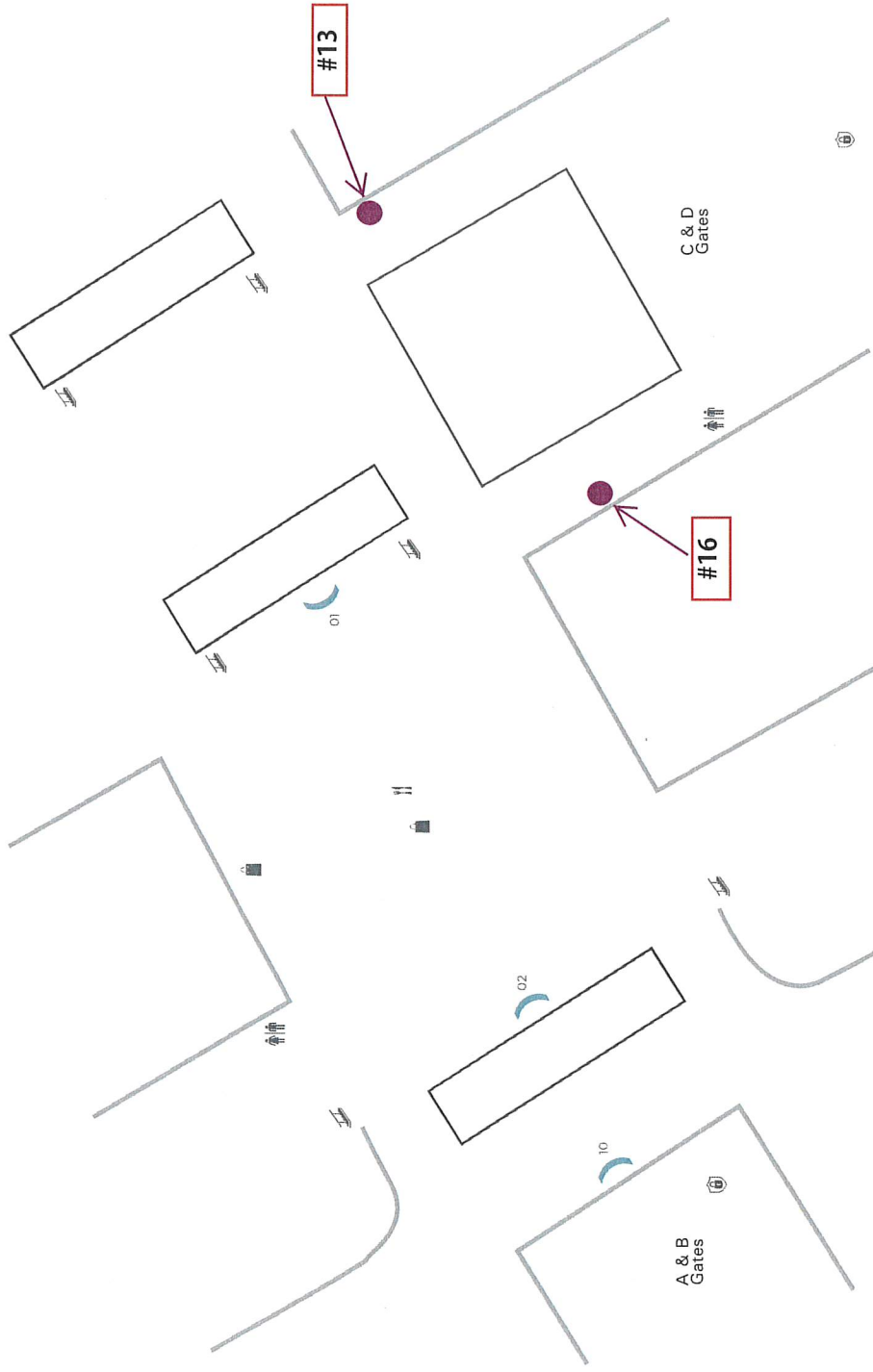
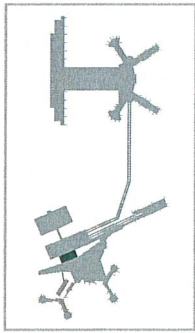

- Banner Grip
- Escalator
- Food And Beverage
- Shopping
- Bathroom
- TSA / Security

TERMINAL 1 TAXI LINE + OUTDOOR

EXHIBIT "A"

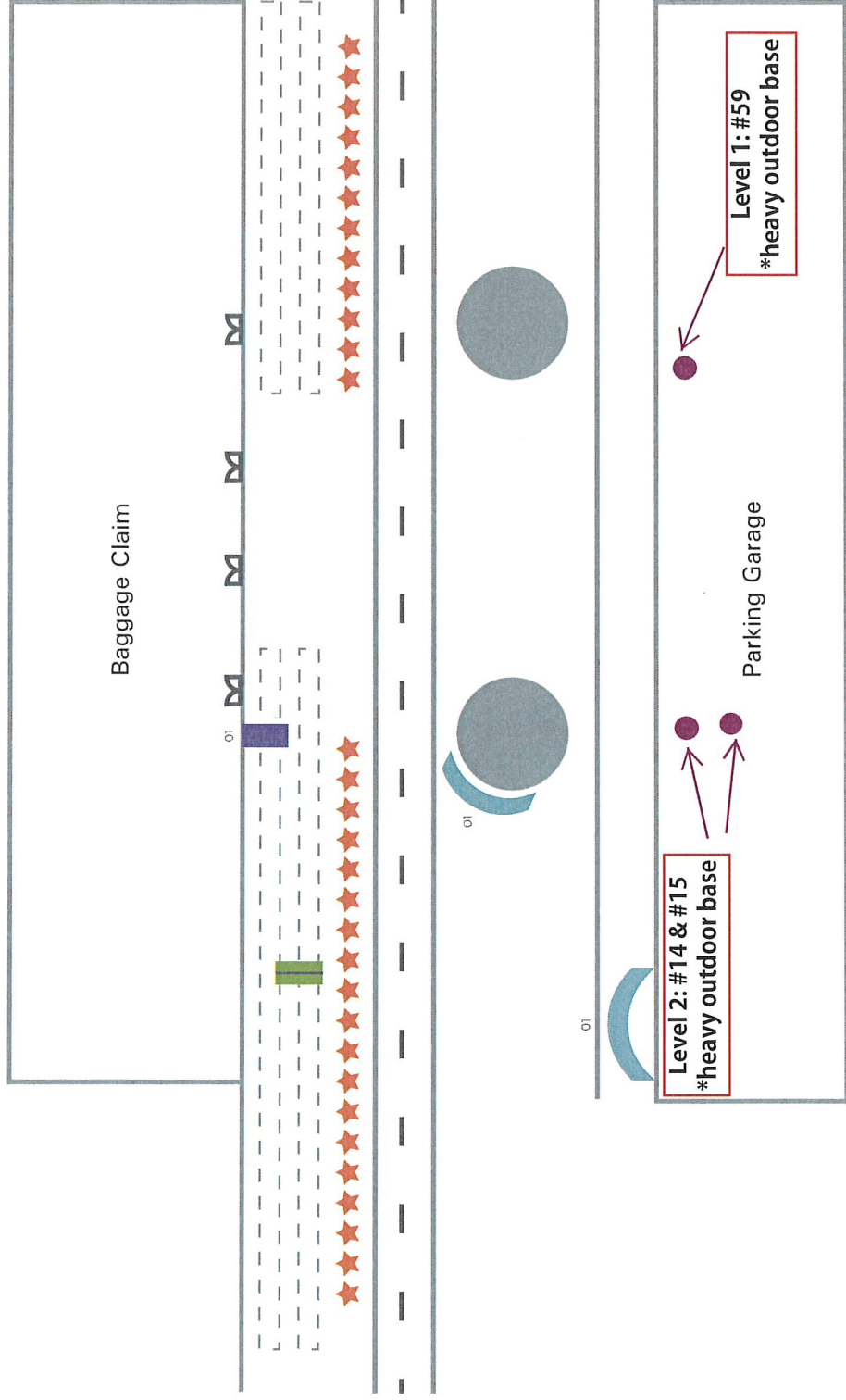
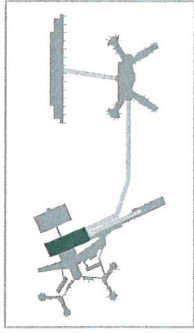

- Custom Spectacular
- Taxi Line Digital (TDN)
- ⤿ Banner
- ★ Taxi Line Sponsorship

TERMINAL 1 TICKETING

EXHIBIT "A"

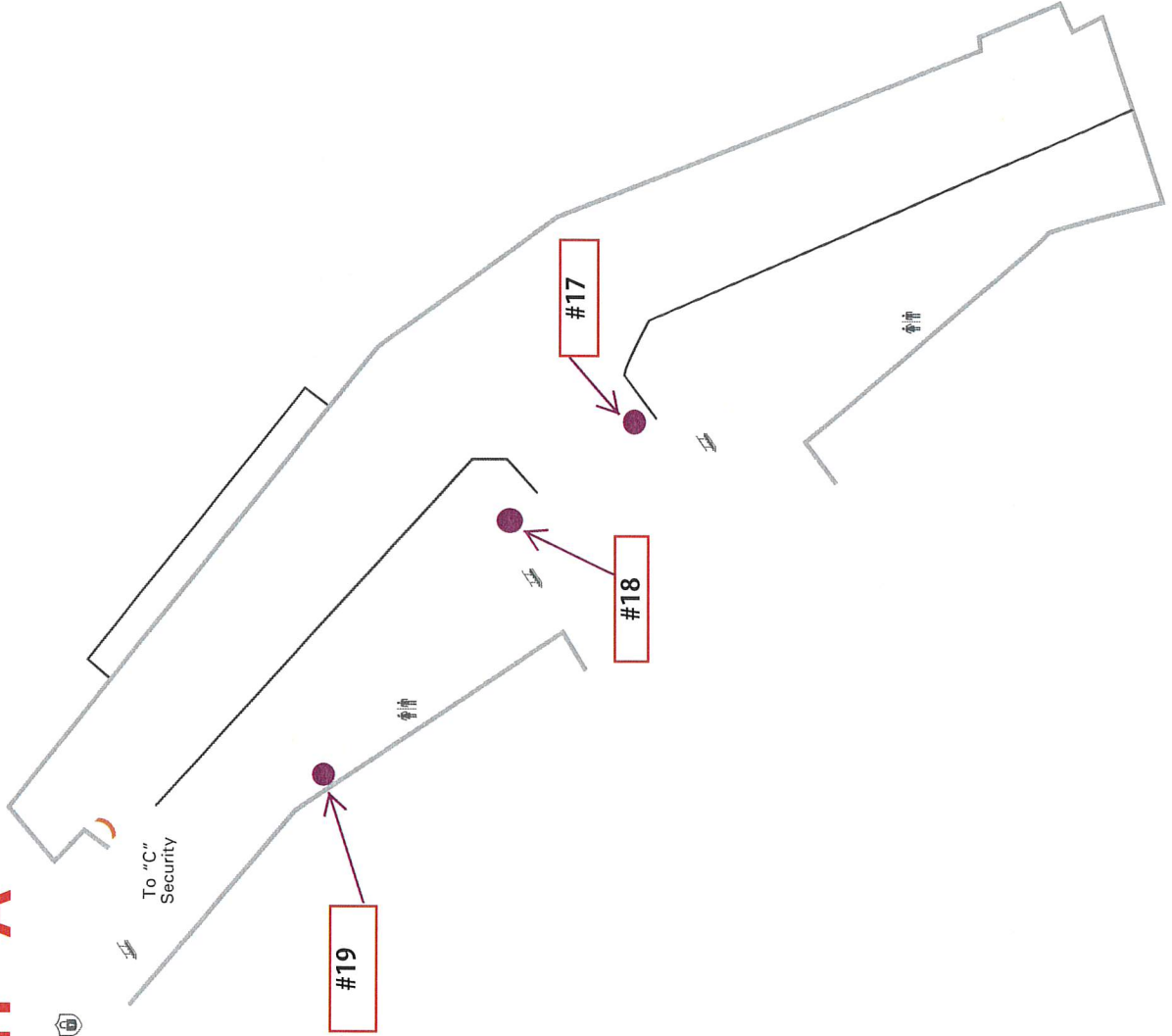
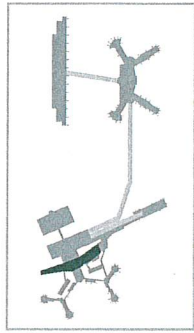







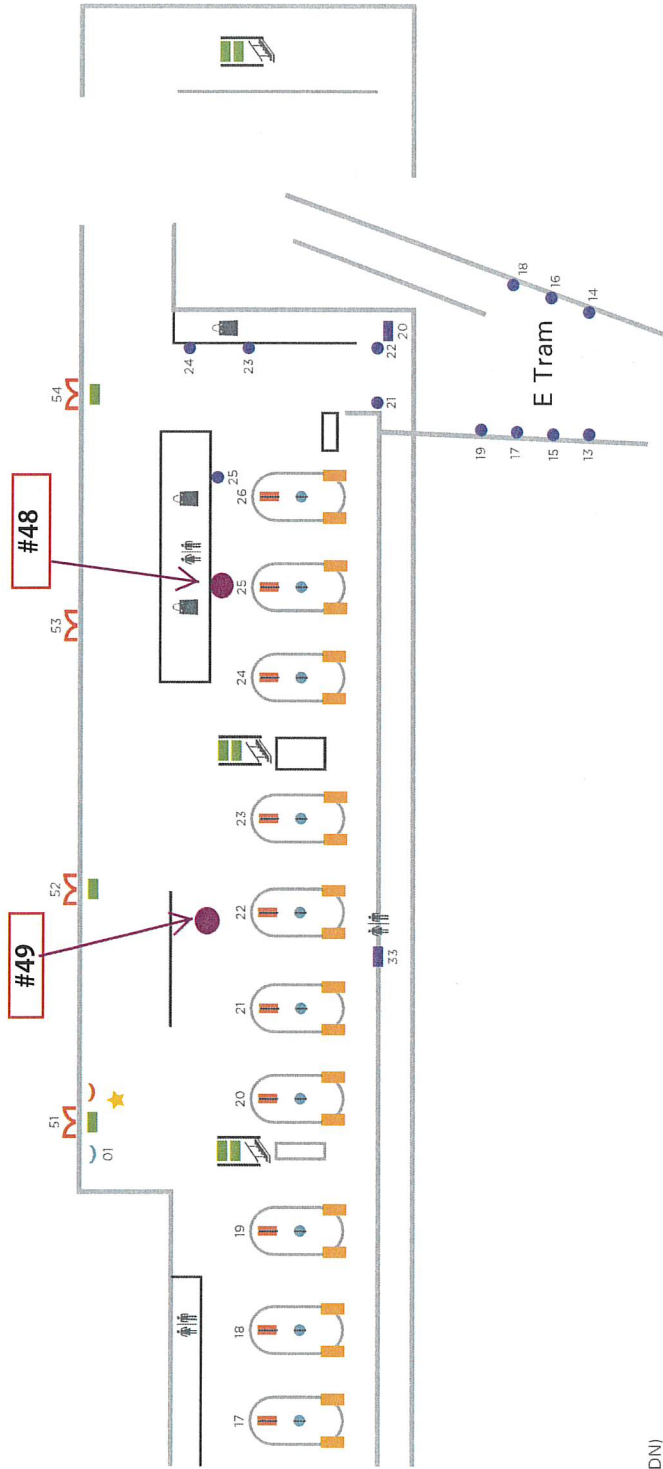
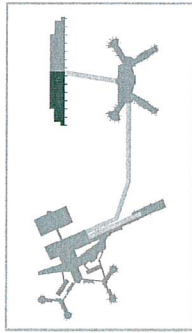





- Wall Wrap
- Escalator
- Bathroom
- TSA / Security

TERMINAL 3 BAGGAGE CLAIM

EXHIBIT "A"



-  Banner Digital Network (BDN)
-  Audio Video Digital Network (AVDN)
-  Extra Large Wall Diorama
-  Custom Spectacular
-  Baggage Carousel Digital Network (BCDN)
-  Domestic Digital Network (DDN)
-  Banner Grip
-  Wall Wrap
-  Floor Display
-  Exit Sponsorship
-  Shopping
-  Escalator
-  Bathroom

TERMINAL 3 CONCOURSE E EAST

EXHIBIT "A"

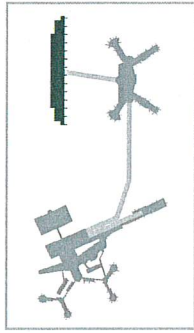

- | | |
|-----------------|-----------------|
| AeroMexico | Korean Air |
| British Airways | Norwegian |
| Condor | Virgin Atlantic |
| COPA Airlines | VivaAerobus |
| Hainan Airlines | Volaris |
| Interjet | WestJet |
| Swoop | Air Canada |

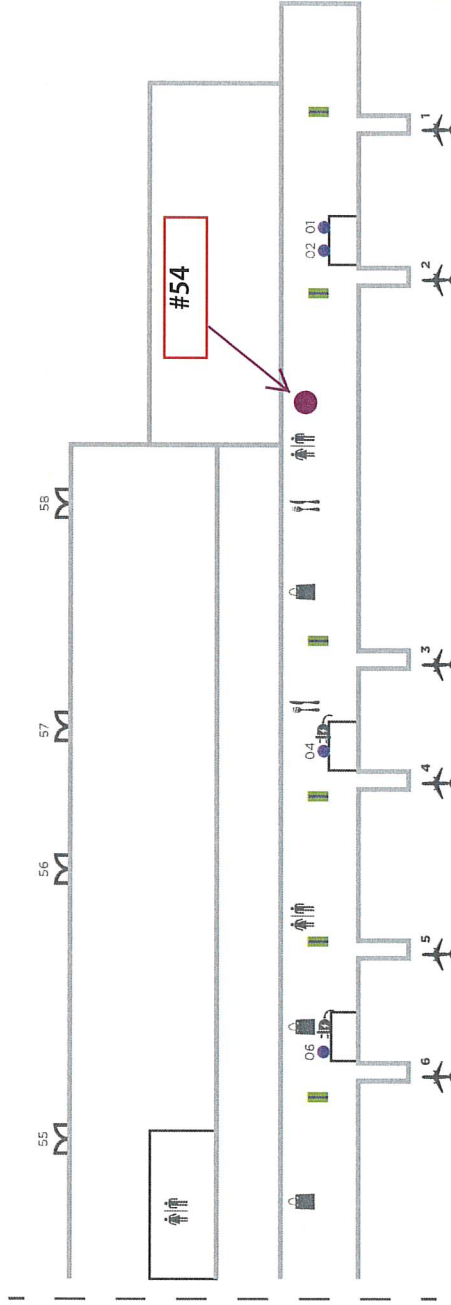

-  Extra Large Wall Diorama
-  Concourse Digital Network (CDN)
-  Entrance and Exit
-  Escalator
-  Recharge Zone
-  Food and Beverage
-  Shopping
-  Bathroom

TERMINAL 3 CONCOURSE E WEST

EXHIBIT "A"

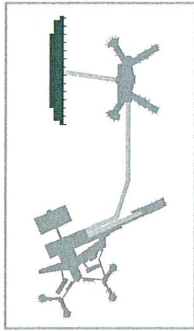

Alaska
Jet Blue
OAI
West Jet

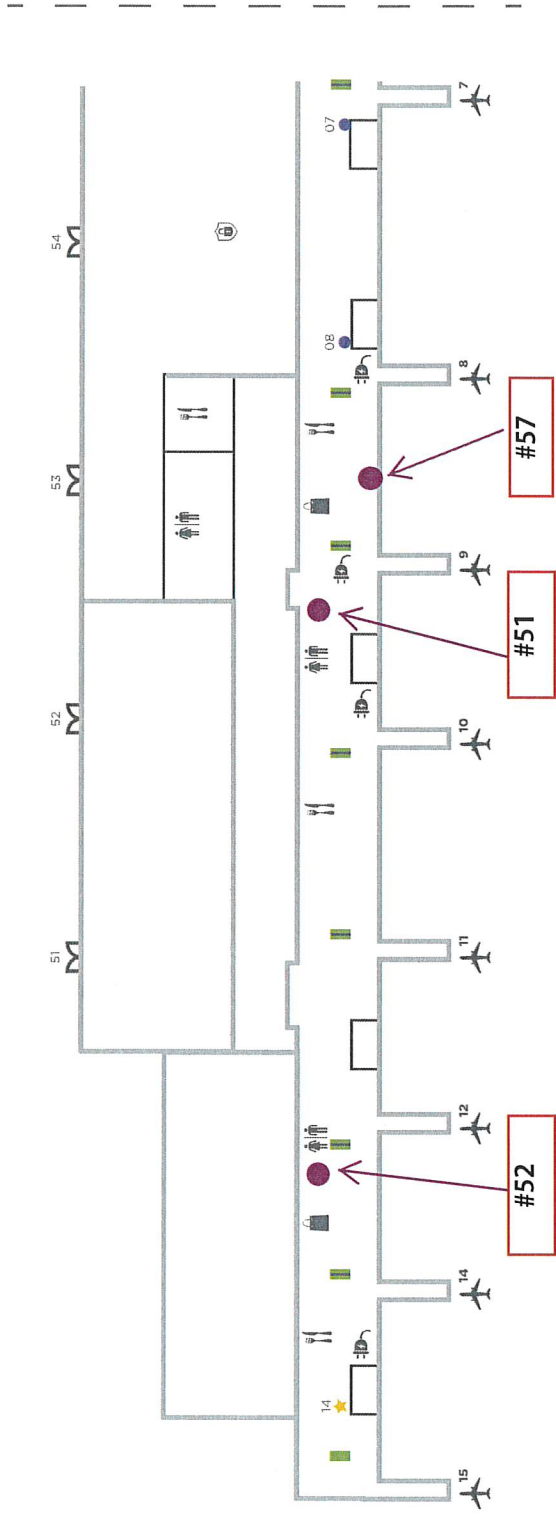

- Extra Large Wall Diorama
- Concourse Digital Network (CDN)
- M Entrance and Exit
- Escalator
- Recharge Zone
- Food and Beverage
- Shopping
- Bathroom

TERMINAL 3 TAXI LINE + OUTDOOR

EXHIBIT "A"

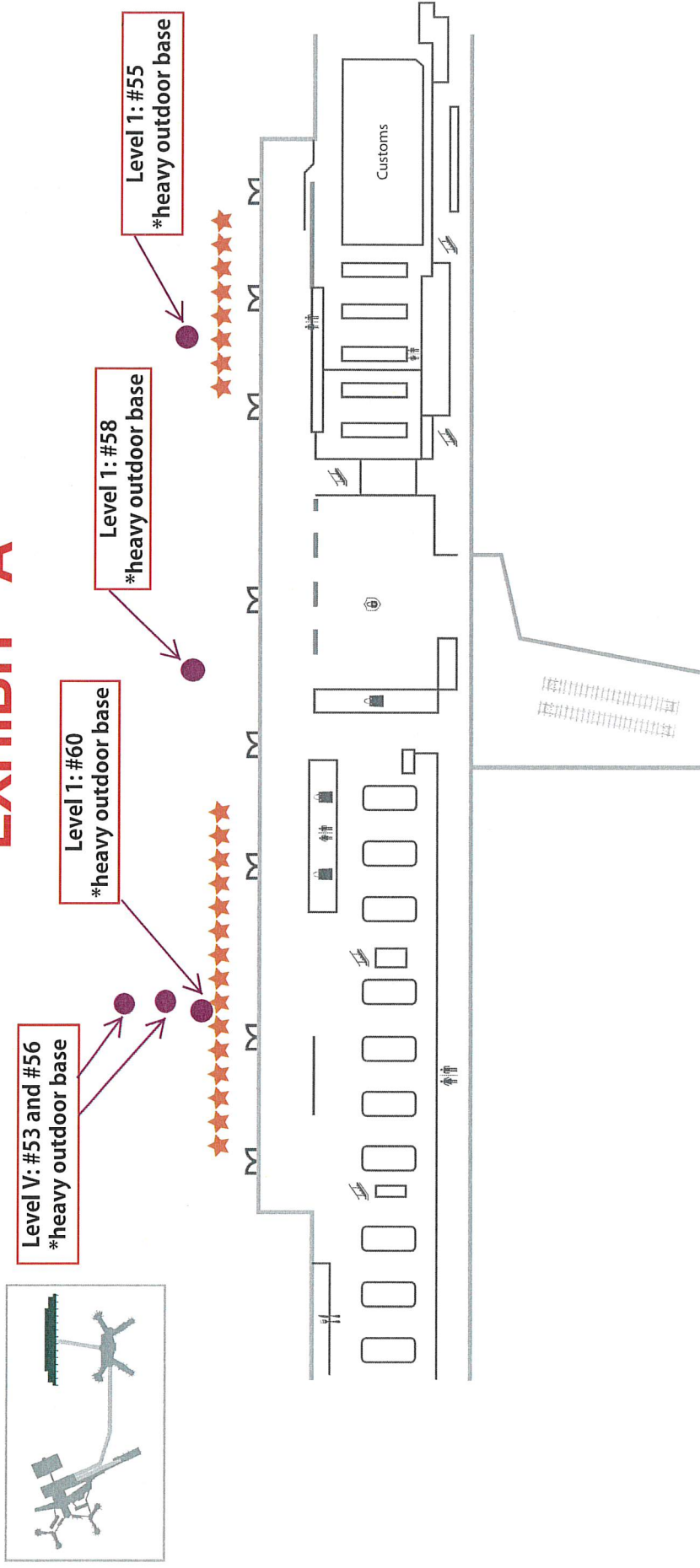

TERMINAL A + B ROTUNDA

EXHIBIT "A"

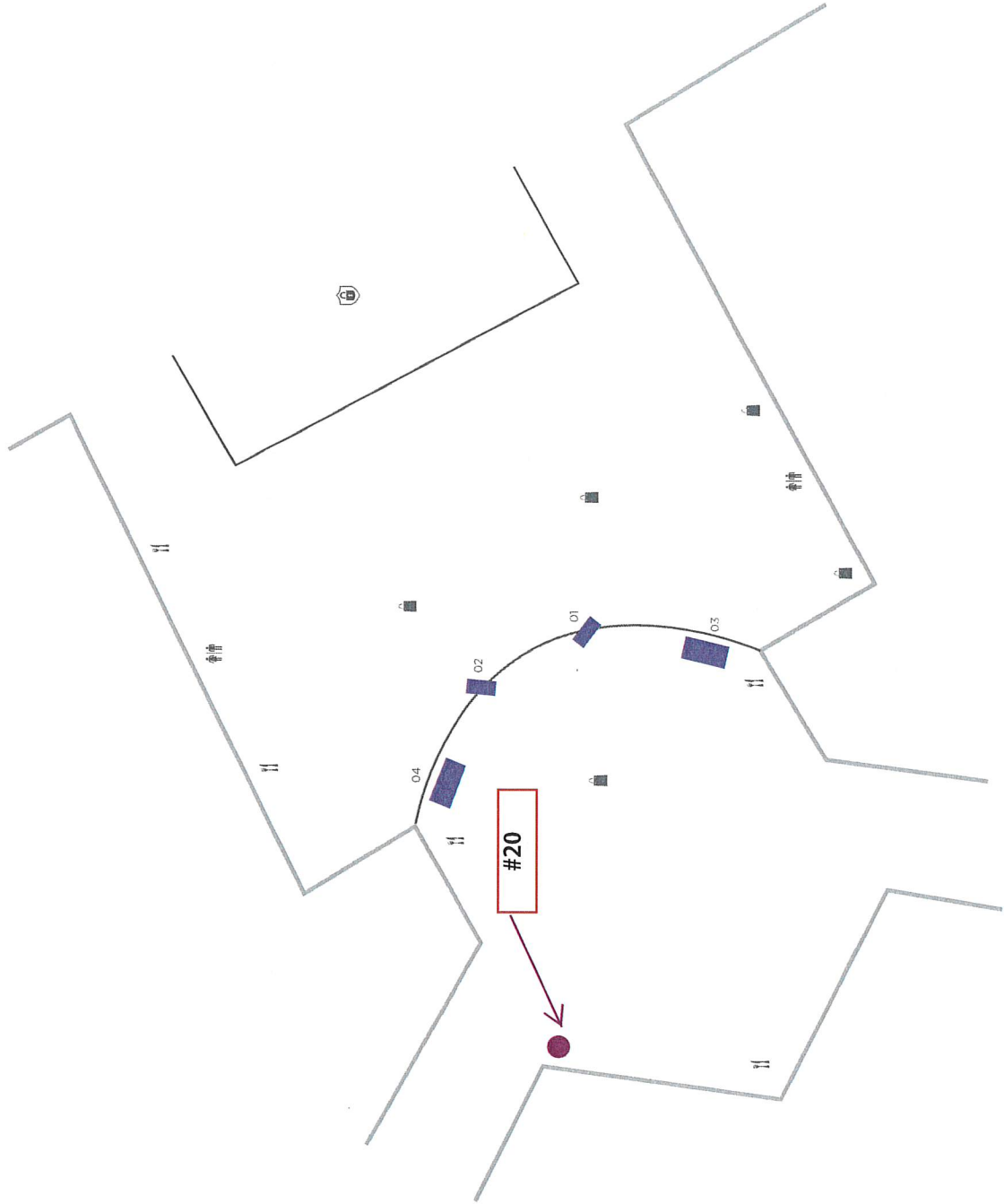
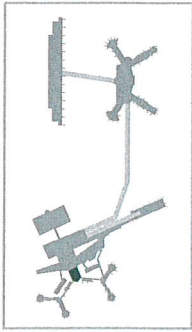

- Custom Spectacular
- Food And Beverage
- Shopping
- Bathroom
- TSA / Security

EXHIBIT "B"

PERFORMANCE MEASURES AND SCOPE OF SERVICES

1. GENERAL

It is the intent of the Clark County Department of Aviation ("County" or "Aviation") to provide world-class aviation services to its customers that utilize the Airport. Company is responsible for upholding Aviation's customer service standards as follows:

- 1.1 Company shall furnish all management, labor, and supplies necessary for the efficient and effective operation of services included in this Agreement.
- 1.2 Company shall be responsible to plan, develop, coordinate, manage, and operate the services in accordance with this Agreement in order to enhance customer service at the Airport.
- 1.3 Company shall submit, upon request by the Director, its policies and procedures manual. At the request of the Director, Company shall promptly address any Company policies and procedures that conflict with this Agreement.
- 1.4 The Director will have the right to establish reasonable rules and regulations and/or operating directives, and Company agrees to comply with such rules and regulations.
- 1.5 Company shall furnish its employees working at the Airport with standardized uniforms subject to approval by the Director. Such uniforms shall be of a color and style distinct from Aviation employees and shall be representative of a world-class and/or high standard of operation. In addition to the required Aviation identification badging, each employee will wear a uniform name tag identifying the employee, the service being provided and the Company's name, and in the case of supervisors and managers, their specific job title. All of the Company's employees must wear their uniforms at all times while performing services under this Agreement.
- 1.6 Company shall be fully responsible for the acts or omissions of its agents, employees, contractors, subcontractors, or their agents or employees, performing services under this Agreement.
- 1.7 Employees shall be instructed to park in an area designated by the Director at the rates set forth by Aviation, and such employees shall be appropriately badged in accordance with governing regulations.

2. START-UP

Company shall be responsible for preparing and managing an orderly and effective transition and startup of the services under this Agreement. This may include, but is not limited to,

meeting with Aviation staff, assisting Aviation with the physical development of the Assigned Areas, and placing or installing fixtures and equipment for Company's operations at the Airport.

3. SAFETY

Company shall be responsible for implementing a comprehensive Accident Prevention and Safety program to be used by staff. First aid supplies as well as fire extinguishers must be available for use as necessary. Company shall be responsible for training all employees on the use of all emergency, fire equipment, and environmental hazards and be cognizant of the locations of all such equipment and/or materials. Aviation will provide an initial orientation to the Assigned Areas and location of safety equipment within the Airport, including information on any specific Airport rules/regulations necessary for Company to comply with the provisions of this Section. All accidents and incidents involving employees shall be verbally reported to the Airport Control Center immediately followed by written confirmation of the same to Director, containing all pertinent information and in a form approved by the Director, within twenty-four (24) hours of the incident.

4. PERSONNEL POLICIES AND PROCEDURES

The Company's personnel includes its employees, staff, agents, contractors and representatives. The Company is solely responsible for managing its personnel to comply with both the Company's requirements and Aviation's requirements.

- 4.1 Company will employ, train, schedule and assign management and supervisory personnel to sufficiently and competently perform daily management, supervision, record keeping, and customer service duties required for the efficient and effective operation of the Company at the Airport. All such persons will be selected and assigned based on the highest level of competency, honesty, and courteous service available to Company through diligent recruiting, selection, and training.
- 4.2 Company will employ and staff for each shift a sufficient number of personnel to handle the operations and respond to customer inquiries and the needs of the business conducted under this Agreement, especially during peak operational hours.
- 4.3 Company shall maintain and conduct its operations in proper business-like manner so as not to disturb or be offensive to other tenants, customer, or passengers. Company shall not solicit business anywhere at the Airport, except in proper manner within the Assigned Areas.
- 4.4 All personnel employed by Company or Company's agents, while on duty, will at all-time wear uniforms which are in a clean, neat, well-fitting condition with the logo identifying the Company name and name identification tags.

- 4.5 There shall be at least one employee designated as a supervisor on duty during all hours of operations.
- 4.6 All Company personnel shall be fully qualified and licensed under any and all federal, state, and local laws to perform Company's allowed services, as applicable.
- 4.7 Company shall remove from all Airport locations any employees who, in the reasonable opinion of the Director, conduct themselves improperly, are not qualified, or are not licensed to perform the required services.
- 4.8 Company will ensure that employees under this Agreement:
- A. If applicable, are bonded against theft, embezzlement, and other losses of customer personal property and/or property of Aviation;
 - B. Are familiar with the duties and responsibilities of Company under this Agreement;
 - C. Are alert, attentive and responsive while on duty;
 - D. Do not commit any act which may bring discredit upon Aviation;
 - E. At all times exercise prudent, mature judgment in taking whatever action is necessary to protect its customers, the travelling public, Aviation's property, as well as to ensure normal, efficient operations;
 - F. Maintain a valid Nevada State Driver's License appropriate for the types of vehicles being driven (Minimum of Class "C"), as applicable;
 - G. Obey all Rules and Regulations.
- 4.9 Company shall ensure that all supervisory personnel assigned to perform the services under this Agreement:
- A. Are trained, experienced, and of mature judgment;
 - B. Have authority, responsibility, and are able to provide direction to and exercise control over employees;
 - C. Are available for immediate response and will respond to all calls for assistance;
 - D. Are known to the employees and conduct frequent inspections to ensure that all Assigned Areas are properly staffed with qualified employees and areas are kept clean.

- 4.10 To ensure staffing and proper ratios are adhered to, Company shall submit copies of employee work schedules for approval of the Director, when requested.
- 4.11 All Company personnel shall present a professional, positive, pleasant, and courteous attitude. All employees will act in a courteous and helpful manner at all times with all customers and all other employees.
- 4.12 Employees will be considered courteous if they meet the following standards:
- A. Provide a friendly and professional greeting to all customers whenever and wherever they make contact.
 - B. Display a positive attitude toward passengers and fellow employees.
 - C. Maintain a friendly and attentive demeanor and good posture at all times.
 - D. Remain calm when encountering an upset customer, listen carefully, and show empathy to the problem.
 - E. Speak English clearly and understandably without using slang.
 - F. Never use foul or inappropriate language at any time in any public area.
 - G. Use proper and courteous language with customers, including using words such as “please,” “yes,” “hello,” “thank you” and such other similar polite words.
 - H. Smile and maintain appropriate eye contact and tone of voice while conversing with customers as well as fellow employees.
 - I. Respond to customers in areas that may not be within their specific job scope.
 - J. Do not gather together to chat while on duty.
 - K. Do not eat or smoke at their workplace in view of customers.
 - L. Do not chew gum, eat, or drink in public areas, other than those designated for such activities.
 - M. Wear nametag or appropriate identification at all times and always be identifiable as Company’s personnel.
 - N. Do not nap or sleep while on duty.

- O. Present a well-groomed, neat, clean, and conservative professional appearance.
- P. Wear only appropriate accessories.
- Q. Wear a uniform that is consistent for the type of job being performed and that is neat and clean.
- R. Convey information using clearly understandable terms and provide accurate information to customers.
- S. Obtain assistance to resolve customers' questions or problems if language barriers arise.

5. WORK AREA STANDARDS

Company shall be responsible for ensuring that their Assigned Areas are maintained in a neat, safe, and professional manner. This shall include, but is not limited to, the following:

- 5.1 Counters are neat and clean with no graffiti.
- 5.2 Workspaces appear uncluttered.
- 5.3 Employee's personal belongings are not visible.
- 5.4 No unauthorized postings.
- 5.5 No handwritten, unprofessional, or unauthorized signs.
- 5.6 Wastebaskets are not overflowing and floor area is clean.
- 5.7 Supplies and equipment are stored out of sight of customers when not in use.
- 5.8 All inoperable, unused, and/or abandoned equipment will be removed from the Airport.
- 5.9 Whenever electric or otherwise motorized carts or vehicles are used in connection with this Agreement, as authorized by Aviation, Company agrees to abide by rules, regulations, or other methods of control and safety as may be established by Aviation related to the use of such vehicles. Such operation will only be in areas and at such times as approved by Aviation. All carts and vehicles used by Company must be stored and maintained in a manner acceptable to Aviation.

6. ADDITIONAL REQUIREMENTS

Company shall provide the following services for Aviation and/or its customers under this Agreement:

6.1 Supervision and Coordination

- A. Company shall require its employees to only use designated break areas during work breaks.
- B. Company shall provide to Aviation all Company training and safety records upon Aviation's request.
- C. Company shall communicate and cooperate with the Director, which includes Aviation's designated representatives, as required.
- D. Company shall check and verify availability and preparedness of personnel, equipment, supplies, and services required for Company to properly operate at its Assigned Areas.

6.2 Customer Service

- A. Company will provide evidence to Aviation that its employees have successfully completed Company's customer service and employee training.
- B. Company will respond to customer complaints received by either Company or Aviation within 24 hours from receipt of said complaints. Company will also provide Aviation with a summary detailing Company's efforts to satisfactorily resolve customer complaints within five (5) days from receiving such complaints.
- C. All customers should be courteously greeted upon entering the Assigned Areas.
- D. Employees are prohibited from eating, drinking, or resting in view of the public while in the Assigned Areas.
- E. Employees should refrain from using their cell phone, tablet, laptop, and/or any other personal electronic device while working in the Assigned Areas.

6.3 Store Operations

- A. Assigned Areas will be open during the hours approved by Aviation, and said hours shall be posted in a visible location for the public to view.

- B. Assigned Areas will be clean, neat, accessible, well-lit and fully stocked at all times.
- C. Assigned Areas will be properly staffed to handle peak operational times.
- D. All trash will be out of public view.
- E. All boxes will be disposed of immediately or be placed out of the public view.
- F. During operations, the Assigned Areas will have a manager and/or supervisor present.
- G. Employees will be dressed in the dress code submitted by Company and approved by Aviation. Employees observed not in the approved dress code may be asked to leave the Assigned Areas.
- H. Deliveries should be stocked immediately or put out of the public view until they can be stocked.
- I. Deliveries to the Assigned Areas will comply with TSA's regulations.
- J. Cameras in the Assigned Areas are permitted with approval from Aviation.
- K. All employees must remain inside the Assigned Areas at all times while conducting business, and they may only greet customers and distribute samples to those customers who enter the Assigned Areas.

6.4 Storage Areas

- A. Aviation may provide Company with a designated area for storing goods and equipment ("Storage Area"). Any such Storage Area will utilize a door lock and key system that is acceptable to, and approved by, Aviation.
- B. Deliveries to the Storage Area will comply with TSA's regulations.
- C. Deliveries will be put in the Storage Area immediately and not be stored in the loading dock and/or sally ports.

- D. The Storage Area (cage or inline) will have a professionally made sign indicating the Company's name and contact information.
- E. The Storage Area will be free from trash, food waste, and/or any other item that may create a safety or environmental hazard.
- F. Broken fixtures and/or equipment cannot be stored at the Airport.
- G. Company will ensure it has enough properly badged employees to access the Storage Area.
- H. Barbwire on top of a caged Storage Area may be permitted with approval from Aviation.
- I. Cameras in the Storage Area may be permitted with approval from Aviation.

6.5 Security and TSA Regulatory Compliance – Concession Prohibited Items

- A. The Company shall not sell, store or possess any items which may be classified by Aviation or the TSA as prohibited under applicable security regulations, as may be modified from time to time.